

# The Effect of Heavy Loads on the Accuracy and Linearity of Operational Amplifier Circuits (or, "What's All this Output Impedance Stuff, Anyhow?")

National Semiconductor  
Application Note 1485  
Bob Pease  
May 7, 2008



The Effect of Heavy Loads on the Accuracy and Linearity of Operational Amplifier Circuits

## Introduction

It is well known that the ideal operational amplifier (op amp) should have very high gain, very high bandwidth, very high input impedance, and very low output impedance. <sup>1</sup> It is possible to get conventional amplifiers with very high gain (120 dB or higher), and very high bandwidth (100 MHz, 1000 MHz, or more). However, most op amps do not have a very low open-loop output impedance ( $Z_{out}$ ). Only a few are as low as 50 ohms, and can drive a 50-ohm load without any significant degradation of gain (barely 2:1). See *Figure 1*.

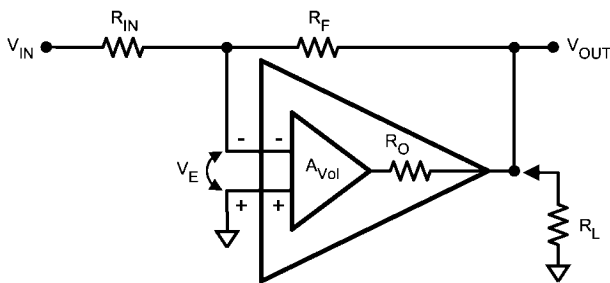

$$A_V \cong \frac{V_{OUT}}{V_E} \cong A_{VO} \cdot \frac{R_L}{R_O + R_L}$$

20194945

**FIGURE 1. Model of Operational Amplifier (Op-Amp) with finite output impedance  $R_o$ . If  $R_o$  is significant compared to  $R_L$ , the effective  $A_v$  ( $V_{out}/V_E$ ) will be degraded vs.  $A_{vol}$ .**

Many op amps designed over the last 50 years have Class B or class A-B emitter-follower output stages, which help provide low output impedance and high efficiency. Many of these use mature bipolar transistor technology, and can operate on  $\pm 15$  volts. See *Figure 2a*.

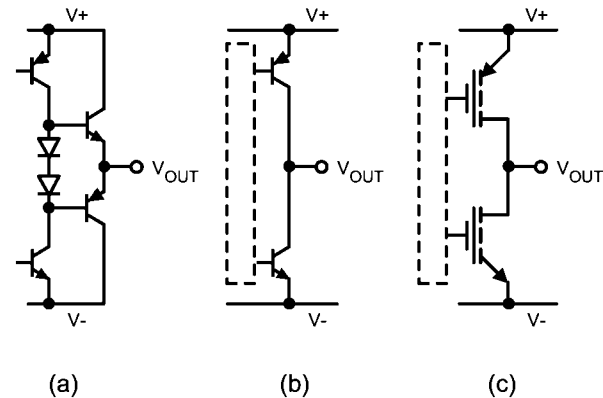

20194946

**FIGURE 2. (a) Conventional high-gain Op-Amp with emitter-follower output stage (simplified). (b) Op-amp with collector-loaded "rail-to-rail" output stage (simplified). (c) CMOS Op-amp with drain-loaded "rail-to-rail" output stage (simplified)**

It is also known that the closed-loop output impedance of a typical operational amplifier can be MUCH lower than the open-loop output impedance. If an op amp has, for example, an open-loop gain of 10,000, and its open-loop output impedance is 50 ohms, the output impedance after the loop is closed can be as low as 50 milliohms or lower, depending on the application (assuming the amplifier is used at a gain of 5 or lower). So for many applications, at least at low frequencies, it is a fair statement that the closed-loop output impedance can be very low.

However, a new class of amplifiers has been introduced over the last 30 years, which do not have emitter-follower outputs. Why not? Because many of the new amplifiers are designed to operate on low voltages such as  $\pm 5$  volts, or  $\pm 2.5$  volt, or  $\pm 0.9$  volts or sometimes even lower. For maximum signal-to-noise ratio, the output must swing from (nearly) the + rail to (nearly) the - rail. <sup>2</sup>

Obviously any emitter-followers would reduce the output swing by about 0.7 volts in either direction (and even worse at cold temperatures), so amplifier designs that use followers have become obsolete for such low-voltage applications. See *Figure 2b*.

The first "rail-to-rail" output stage was introduced in Bob Widlar's LM10. This was designed and released in 1976, and is still in production. It can operate from  $\pm 20$  volts to  $\pm 0.6$  volts (or from 40 volts down to 1.2-volts of total power supply) and its output can swing within a few dozens millivolts of the power supply rails. It does not have any output emitter followers. The LM10's output consists of one big NPN output stage to pull the output down, and sink 15 to 20 mA of current, and comparable PNP transistors to source as much as 15 to 20 mA. It has some very complicated bias circuits to make sure these two transistors take turns at driving the load, as required. *Figure 2b.*

More recently, over the last 15 years, there have been dozens of different designs, mostly using CMOS technology, and all have "Drain-loaded" outputs, with N-channel and P-channel FETs which can source and sink many milliamperes, *Figure 2c.* These all have high output impedances. One way to look at it is, that the gain gets lower when you load the output with a heavy load. Another way to look at it is, that the gain RISES when the load gets lighter. See *Figure 3.*

In concept, a Drain-loaded output stage could use negative feedback to an internal stage, so that the gain would not change much as the load gets heavy or light. Practically, it would take a lot of high-value resistors to accomplish this, and such resistors would be very expensive in monolithic IC technology. In practice, the disadvantage that the gain changes as the load is changed, is not serious. This is largely because the gain is very high when the load is heavy, and it just gets higher when the load is lightened.

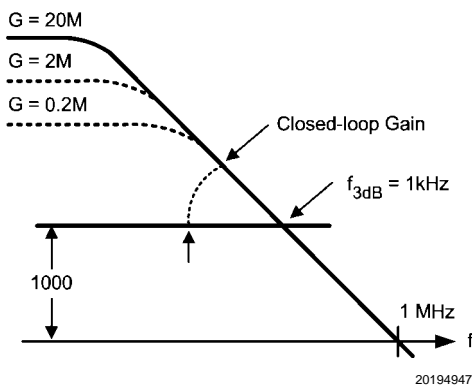

**FIGURE 3. Bode plot for high-gain amplifiers with various DC gains, operating at a gain of 1000.**

I once heard some engineers argue that there is no advantage when an op amp's gain gets very high, and in concept there may be disadvantages. One argument is that there is no need for any op-amp to have a gain greater than 200,000, because if the gain gets higher, it would have to be tested at very low frequencies, lower than 0.1 Hz. Such testing would take many seconds, and this testing would be quite expensive, and nobody would want to pay for that.

However, this turns out to be untrue, as modern amplifier testing can resolve a "dc gain" as high as 2 million or 20 million, in just a few milliseconds. No 20-second test is required. An operational amplifier with 1 MHz of Gain-Bandwidth Product, operating at a closed-loop gain of 1000, has a closed-loop bandwidth of 1 kHz. Thus its time constant is 160  $\mu$ seconds, and it can settle in less than 20 tau, or 4 milliseconds, per *Figure 3.*

In its gain test, the output is required to go to its positive rated output, and the input error settles quickly and is then mea-

sured, for perhaps 16 milliseconds. The output is then required to go to its negative rated output, the input settles, and then is measured again. The gain depends on the reciprocal of the small difference between those input tests. This is easy to do quickly, even for high gains. It takes less than 1/10 second, not "several" seconds, to test for amplifiers even with a gain of 1 million or 10 million or more. See *Figure 3.*

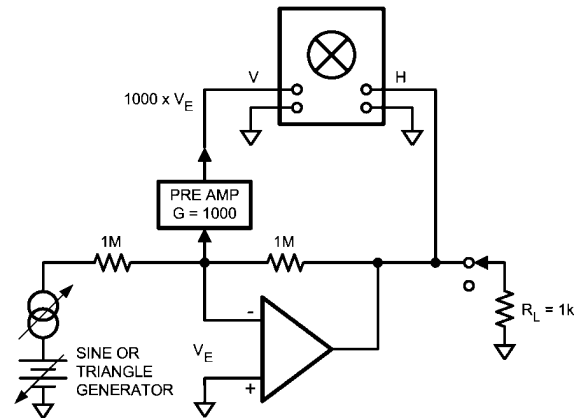

**FIGURE 4. Gain test where  $A_v = 1000 \times V_{out} / 1000 \times V_E$ , using separate preamplifier and X-Y oscilloscope.**

Another argument is that an amplifier with a gain of 2 million or 20 million, would not be useful except for signals slower than 0.1 Hz. This also turns out to be a misconception. If a modern op-amp is connected for a gain of +1000.00, and a 1.0 mV dc signal is applied to the input, the output will settle in a few milliseconds, per *Figure 5.* However, an amplifier with a mere gain of 200,000 would settle its output to 995 millivolts. A gain of 2 million would settle to 999.5 millivolts, and an amplifier with a gain of 20 million will settle to 999.95 millivolts - in milliseconds! MUCH better accuracy.

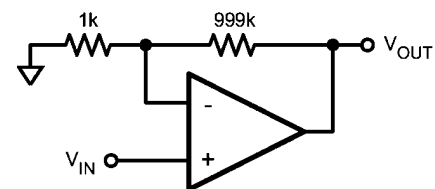
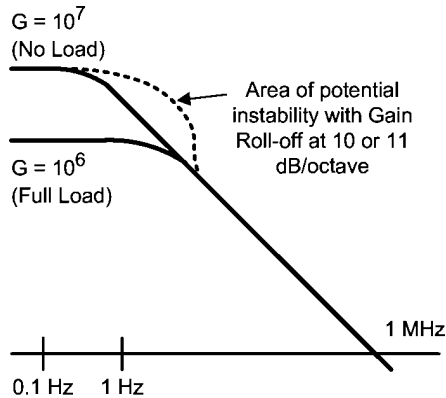

**FIGURE 5. High-gain amplifier operating at a gain of 1000. Its precision depends on high  $A_{vol}$  (and low  $V_{os}$ ).**

Furthermore, if you put in 1.0000 millivolt p-p sine waves, at 5 or 10 Hz or 20 Hz, the output amplitudes of those three amplifiers would be, respectively, 995 mv p-p, 999.5 mv p-p, and 999.95 mV, p-p. Even at 10 or 20 Hz, a precision amplifier can provide enhanced accuracy over low-gain amplifiers. The claim that a high open-loop gain at 0.1 or 0.01 Hz is useless, unless your signal is at 0.01 Hz, is just incorrect.

Some other engineers say that an amplifier with high output impedance and good gain (such as 1 million at 1 Hz) can have its dc gain rise to 10 million or more, if the rated load is taken off. The DC gain would rise so high, they claim, that when it starts to roll off, it would roll off too fast, with excessive phase shift, and be unstable. Refer to *Figure 6.* In actuality, all op-amps these days have smooth 6-dB per octave rolloff, all the way back to very low frequencies. Op amps that rolled off at

10 or 12 dB per octave, when the rated load is taken off, have not been seen for over 30 years.



20194948

**FIGURE 6. High-gain amplifiers with extremely high gain.**

So an operational amplifier with very high gain actually does have some good advantages, and not really any disadvantages.

When an op-amp is asked to drive a heavy output current, it can have large errors if it does not have plenty of  $g_m$  or transconductance. This is true whether it has output followers and low output impedance, OR if it has high output impedance. So the  $g_m$  is very important, and a good amplifier design must have an appropriate amount of  $g_m$  - plenty of *mhos* (milliamperes per millivolt). Many precision amplifiers have many mhos of  $g_m$ . As we shall see, precision amplifiers such as the LM627, LMC6022, and LMP2012 have a  $g_m$  of at least 10,000 mhos. Other popular amplifiers have 50 to 500 mhos. Special-purpose amplifiers may have as little as 2 to 20 mhos, which may be adequate for particular needs.

## Instrumentation

Many modern op amps have such high gain that a preamp with a gain such as 1000 is needed, to let you see the gain error. Even then, a time-based scope does not let you resolve the linear and nonlinear components of the gain error. So I used a Tektronix 2465 (analog) oscilloscope in X-Y (cross-plot) mode. One good way to test the amplifier is to connect the Device Under Test (DUT) as a unity-gain inverter as shown in *Figure 4* and feed the output of the DUT to the scope horizontal display, through a 10X (10 megohm) probe. The output was also fed to one of the vertical channels, so we see the cross-plot of  $V_{out}$  versus itself, as a straight line, with a slope of +45 degrees. Typically, the first amplifiers I tested were high-voltage bipolar amplifiers swinging  $\pm 10$  volts, with the scope set at 5 volts per division. The signal source was a Wavetek 193, with adjustable amplitude and variable DC offset. I used the variable offset to adjust the output to swing exactly  $\pm 10$  volts, for the high-voltage amplifiers. The output swing was set at  $\pm 4$  volt peaks for CMOS amplifiers running on  $\pm 5$  volts, and  $\pm 2.0$  volts for amplifiers running on  $\pm 2.5$  volts, in general.

The -input voltage (the gain error) is fed to a preamp with a gain of +1000. This was sometimes fed directly to the scope's vertical input (DC coupled) at sensitivities varying from 2000 mV to 5 mV per division, yielding a resolution of 2 mV down to 5  $\mu$ V per division. By using the cross-plot mode, it was possible to resolve 1 or 2  $\mu$ V p-p of gain error in the presence of a few microvolts of noise. For amplifiers with large offset voltage, I fed the signal in to the scope's DC input through 11  $\mu$ F, so that 0.2 Hz signals could be resolved without appreciable phase shift.

The test circuit I actually used was *Figure 7*, with the amplifier acting as a unity gain inverter for the signals, and acting as a preamp of gain = 1000 for its own error signals. This makes the test set-up easier. The output voltage is plotted in each Test as a straight line at 45° slope, versus the same signal on the horizontal axis. The output voltage is positive and the output is sourcing current on the right side of each Figure, and the output voltage is negative, and sinking current, on the left.

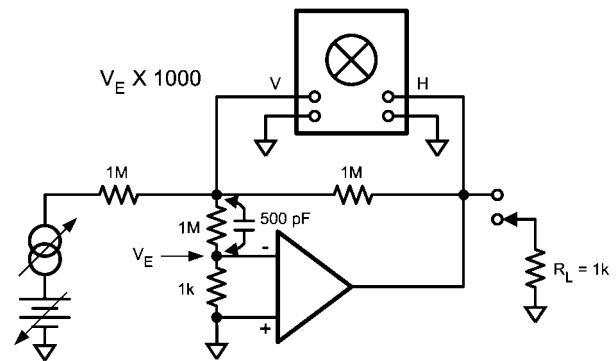

20194950

**FIGURE 7. Gain test where the DUT acts as its own preamp. Gain =  $1001 \times (V_{vert}) / (V_{horiz})$ .**

I generally used a triangle wave for almost all tests. This gave better resolution of p-p errors for the gain test, and it allowed me to run at moderate frequencies (1 to 10 to 80 Hz) and not get the DC gain error signal confounded by the ac gain error. Refer to *Figure 31*, the plot of Test A11. Even though the gain at 8 Hz on this amplifier was just 2,500,000, I was easily able to resolve the 2.5  $\mu$ V of gain error, which is completely independent from the AC gain error. The AC gain error (due to finite gain-bandwidth product) causes the upper and lower traces to separate by 8  $\mu$ V, yet we can still see the "DC" gain error of 2.5  $\mu$ V (gain of 8 million). The gain error is the SLOPE of either the upper or the lower trace, as the output ramps back and forth. This gives much better resolution than a sine wave, and is easier to instrument at a higher sweep rate.

For example... measuring the dc gain of the LMP2012 with Test F01A would require operating at sine frequencies below 0.1 Hz; but by using a 2 Hz triangle wave, we could see that the DC slope would be less than 1  $\mu$ V at 0.01Hz, by "subtracting" the opening between the upper and lower traces.

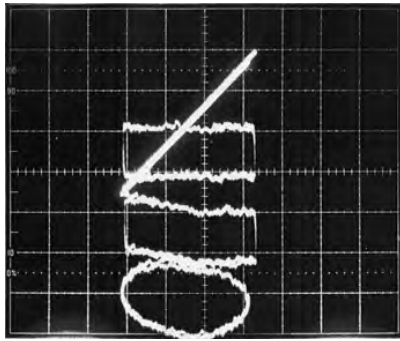

20194907

Test D07B, LMC6022  $F = 2 \text{ Hz}$ .  
 $V_S = \pm 5 \text{ Vdc}$ ;  $V_{out} = \pm 4 \text{ volts peak}$ ,  $I_{out} = \pm 4 \text{ mA peak}$ .  
 Upper Trace: Gain Error, No Load,  $4\mu\text{V p-p}$  at  $20\mu\text{V/div}$ .  
 Middle Trace: Gain Error, Full Load,  $7\mu\text{V p-p}$  at  $20\mu\text{V/div}$ . (TRIANGLE)  
 Lower Trace: Gain Error, Full Load,  $7\mu\text{V p-p}$  at  $20\mu\text{V/div}$ . (SINE)

FIGURE 8.

Also, when we start seeing nonlinearity, we can easily resolve what is nonlinear, because the error correlates with the location on the X-Y plot. In Figure 8, we see the curves taken from Test D07B. This is an example of an amplifier, the LMC6022, with distortion down near  $1/2 \text{ ppm}$  ( $\pm 2 \mu\text{V}$ ). When we use triangle waves it is easy to see this distortion, per the middle trace. If we relied on sine waves, it would be hard to resolve this amount of distortion, per the lowest curve.

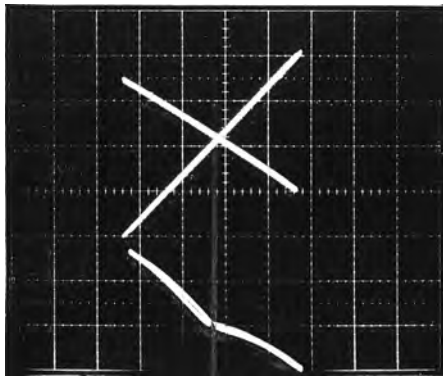

20194921

Test A01, LM709, Curve of Gain Error,  $F = 10 \text{ Hz}$ .  
 $V_S = \pm 15 \text{ Vdc}$ ;  $V_{out} = \pm 10 \text{ volts peak}$ ,  $I_{out} = \pm 10 \text{ mA peak}$ .  
 Upper Trace: Gain Error, No Load,  $480\mu\text{V p-p}$  at  $200\mu\text{V/div}$ .  
 Lower Trace: Gain Error, Full Load,  $540\mu\text{V p-p}$  at  $200\mu\text{V/div}$ .

FIGURE 9.

## Bipolar Amplifiers -- And Funny Errors

I started by measuring the old LM709, one of the first monolithic op-amps, almost 40 years old. This was a good test. The gain error at 1 megohm load was 480 microvolts, so the  $A_v$  was 42,000 at 10 Hz. This was safely better than the 25,000 published spec of the device. I then applied the 1 kilohm load. Most of these op amps were rated to drive a 2 kilohm load, but I put on a 1k load, to see what was going to happen. It made errors about twice as big as they would have been with a 2k load, which was slightly unfair, but helped the resolution of the errors, which were often pretty small. (On rare occasions, I could tell that a 1k load was unfair, so I would re-test at a 2k load, to see what was really going on at rated load.)

In the case of the LM709, (Figure 9) a 1k load actually caused the overall gain slope to degrade by about  $60 \mu\text{V}$ . This corresponds to an output impedance of about 120 ohms, not too bad. However, there was definitely some non-linear error - about  $80 \mu\text{V p-p}$ . Where did that come from? This nonlinear error seems to be bigger than the linear error caused by Zout.

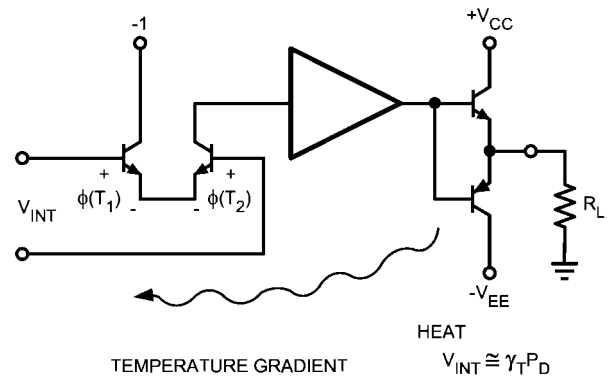

20194952

FIGURE 10. AN-A shows that the heat from an amplifier's output transistors can flow past its input transistors.

This has been thoroughly analyzed in a 1975 technical article, known as NSC Application Note A (AN-A) by James Solomon. This App Note analyzes the circuit and layout of a monolithic amplifier, where an output stage drives a heavy load. One or the other of the output transistors gets warm to the extent of 25 or 50 milliwatts, and sends thermal gradients across the IC chip. See Figure 12. For a complete overview, refer to AN-A at <http://www.national.com/an/AN/AN-A.pdf>. But in their simplest form, the drawings from AN-A are included here. Figure 11 and Figure 13 show that a mere 49 milliwatts can cause a 40 milli-degree C temperature gradient, between the input transistors of the op-amp, located 10 milli-inches apart. If the input transistors were laid out transverse to the heat gradient, they would be heated to the same extent, and the thermal error referred to input could have been quite small. The LM709's input transistors are Q1 and Q2, per Figure 14. They were located along the gradient, 10 milli-inches apart, (Figure 15) and did a very good job of detecting the thermal gradient. Every competitor who copied Widlar's LM709 was afraid to change anything, for fear of making something worse! Even after the LM709 became obsolescent, other amplifiers' layouts still did not do a very good job of rejecting the thermal gradients, for many years.

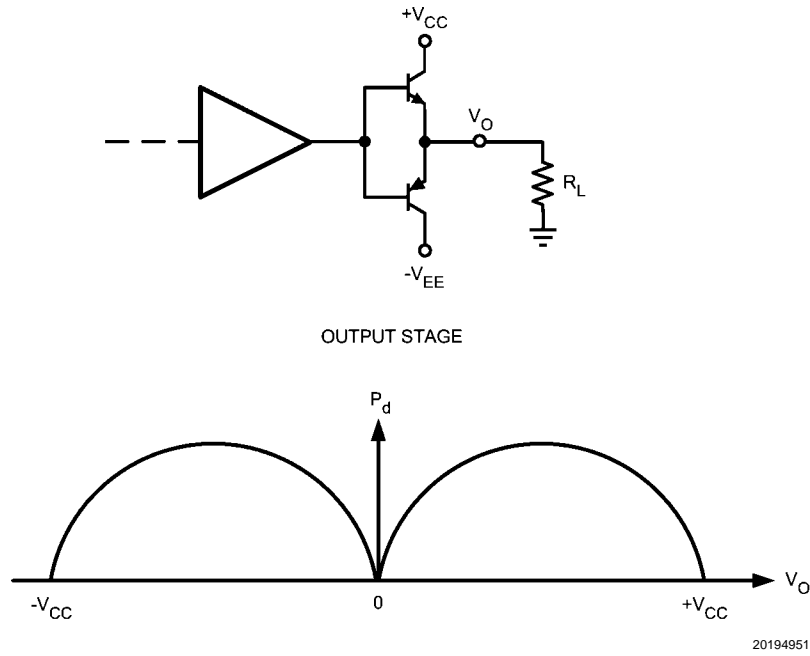

FIGURE 11. AN-A shows the shape of the input error caused by output heat flow, when cross-plotted vs.  $V_{out}$  on an X-Y scope.

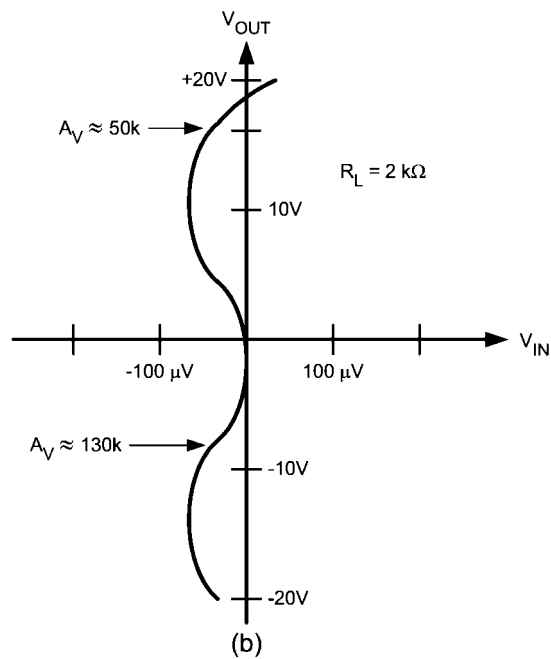
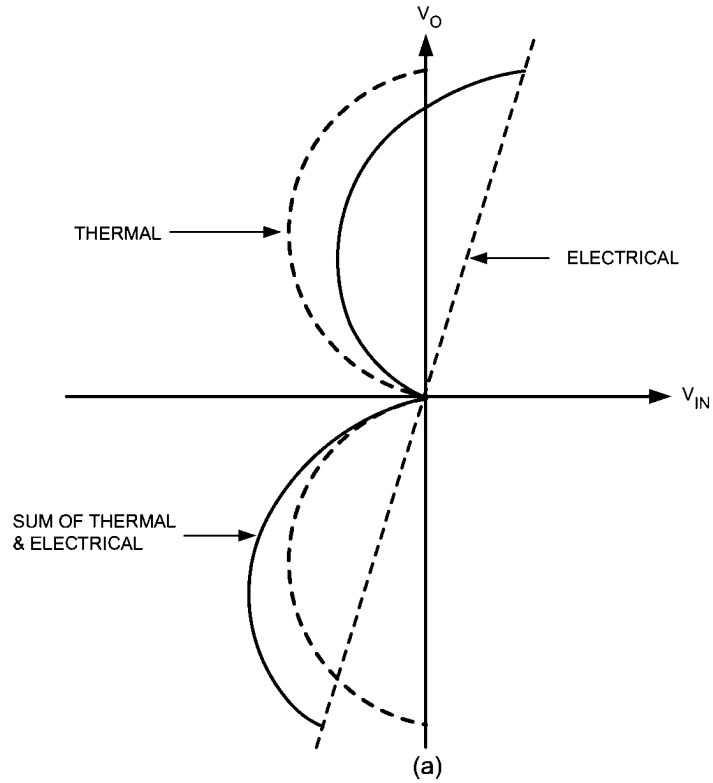
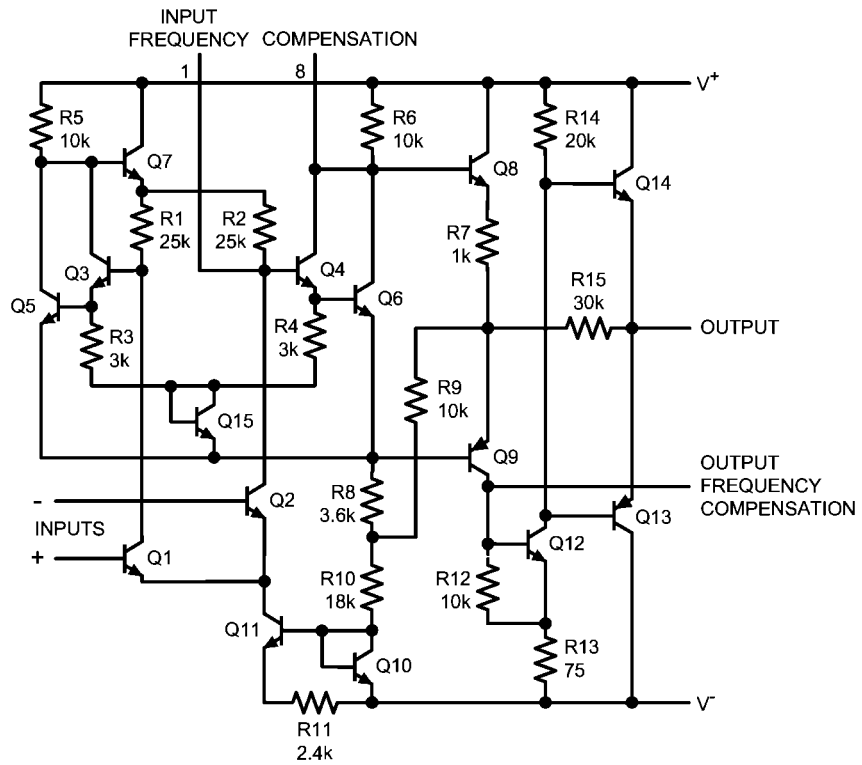

FIGURE 12. AN-A shows the shape of the input error caused by output heat flow, when cross-plotted vs.  $V_{out}$  on an X-Y scope.



20194953

FIGURE 13. AN-A shows that the shape of the error voltage (gain error) can be a summation of electrical and thermal errors. Compare to Figure 9.



20194957

FIGURE 14. Schematic Diagram of the LM709.

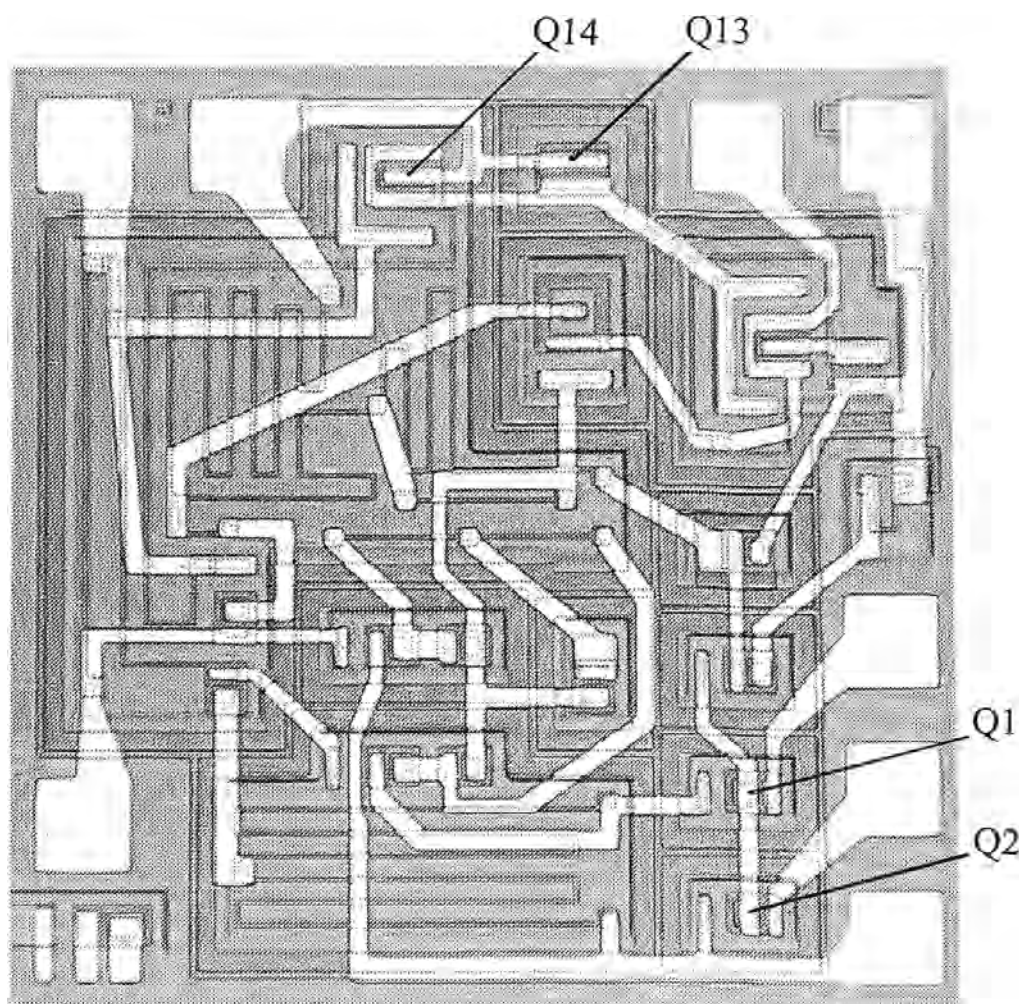

20194958

**FIGURE 15.** Layout of LM709 Die. The spacing from Q1 to Q13 or Q14 is 56 milli-inches, and to Q2 is 10 mils.

Eventually, newer amplifiers took advantage of symmetry and common-centroid layouts (See at "What's All This Common-Centroid Stuff, Anyhow?") <http://www.elecdesign.com/Articles/Index.cfm?ArticleID=6121> <sup>3</sup> to reject thermal gradients. Most of the CMOS amplifiers we will study, below, do not have any appreciable thermal errors, because the CMOS amplifiers were carefully laid out with good layouts to reject thermal gradients. These were accomplished mostly with the use of symmetry, and not with the use of computers. That is because computers are not generally suitable for analyzing the heat flow among the millions of points inside a silicon die, not to mention the thousands of points in time, when a thermal transient occurs. Also, if an amplifier is modelled in SPICE, the SPICE models of most transistors do not allow the transistors to be at different temperatures. New and improved transistor models do now (2001 to 2006) have the ability to analyze temperature differences, but these models are bulky and slow and not highly successful. Symmetry generally works much better.

Other than that, the LM709's gain error was quite adequate for most applications. And if the 709 was run with a load of not such a heavy resistance as 1k or 2k, but 4 k ohms total, its linearity would be as low as 2 ppm. So even the oldest amplifier designs are not too bad.

The next example of a good amplifier with imperfect thermal layout is the familiar LM301A, per *Figure 16*. Its no-load gain was measured at 280,000. But at full load, its non-linear error is also about 80  $\mu\text{V}$  p-p. This, too, gives acceptable over-all performance. *Figure 17* shows an LM301A's thermal errors at various frequencies. The errors at 2 Hz are as expected. When the frequency increases to 20 Hz, the thermal errors are decreasing rapidly. At 200 Hz, they have shrunk to a low level, so the distortion is much less. This is a characteristic of thermal errors, that they decrease rapidly at high frequencies.

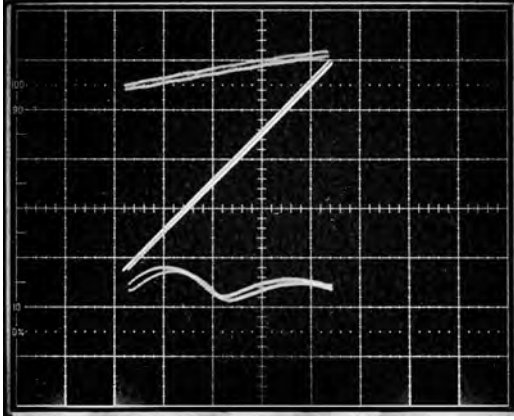

20194961

Test A02, LM301A, Curve of Gain Error,  $F = 5 \text{ Hz}$   
 $V_s = \pm 15 \text{ Vdc}$ ;  $V_{out} = \pm 10 \text{ volts peak}$ ,  $I_{out} = \pm 10 \text{ mA peak}$ .  
 Upper Trace: Gain Error, No Load,  $+75 \mu\text{V p-p}$  at  $100 \mu\text{V/div}$ .  
 Lower Trace: Gain Error, Full Load,  $70 \mu\text{V p-p}$  at  $100 \mu\text{V/div}$ .

FIGURE 16.

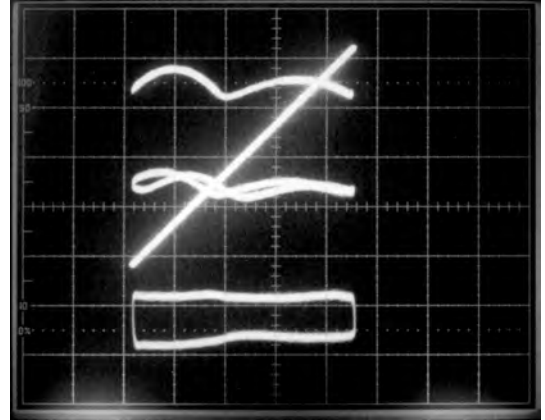

20194962

Test A02B, LM301A, Curve of Gain Error.  
 $V_s = \pm 15 \text{ Vdc}$ ;  $V_{out} = \pm 10 \text{ volts peak}$ ,  $I_{out} = \pm 10 \text{ mA peak}$ .  
 Upper Trace: Gain Error, Full Load,  $60 \mu\text{Vp-p}$  at  $100 \mu\text{V/div.}$ ,  $F = 2 \text{ Hz}$   
 Middle Trace: Gain Error, Full Load,  $60 \mu\text{Vp-p}$  at  $100 \mu\text{V/div.}$ ,  $F = 20 \text{ Hz}$   
 Lower Trace: Gain Error, Full Load,  $25 \mu\text{Vp-p}$  at  $100 \mu\text{V/div.}$ ,  $F = 200 \text{ Hz}$ .

FIGURE 17.



## Group A: High-Voltage Amplifiers

Now we will go through a big list of operational amplifiers that run on  $\pm 15$  volts, and are designed with mostly bipolar transistors. Many of these older amplifiers have imperfect thermal errors, but there are some exceptions.

**Test A01** is the LM709, as we have already discussed, included here just for comparison with the other amplifiers in this group.

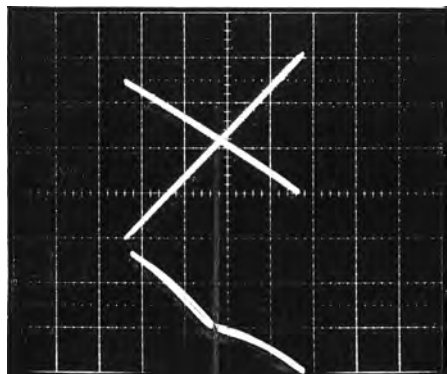

20194921

Test A01, LM709, Curve of Gain Error,  $F = 10$  Hz.

$V_S = \pm 15$  Vdc;  $V_{out} = \pm 10$  volts peak,  $I_{out} = \pm 10$  mA peak.

Upper Trace: Gain Error, No Load,  $480\mu\text{V}$  p-p at  $200\mu\text{V}/\text{div}$ .

Lower Trace: Gain Error, Full Load,  $540\mu\text{V}$  p-p at  $200\mu\text{V}/\text{div}$ .

**FIGURE 18.**

**Test A02** is the LM301, included again, for comparison.

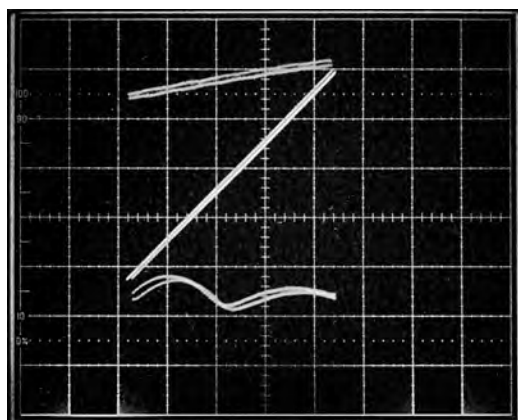

20194961

Test A02, LM101A,  $F = 10$  Hz.

$V_S = \pm 15$  Vdc;  $V_{out} = \pm 10$  volts peak,  $I_{out} = \pm 10$  mA peak.

Upper Trace: Gain Error, No Load,  $+28\mu\text{V}$  p-p at  $20\mu\text{V}/\text{div}$ .

Lower Trace: Gain Error, Full Load,  $30\mu\text{V}$  p-p at  $50\mu\text{V}/\text{div}$ .

**FIGURE 19.**

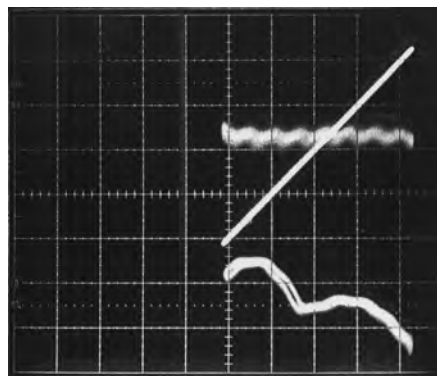

20194923

Test A02B, LM301,  $F = 4$  Hz

$V_S = \pm 15$  Vdc;  $V_{out} = \pm 10$  volts peak,  $I_{out} = \pm 10$  mA Peak.

Upper Trace: Gain Error, No Load,  $6\mu\text{V}$  p-p at  $20\mu\text{V}/\text{div}$ .

Lower Trace: Gain Error, Full Load,  $90\mu\text{V}$  p-p at  $50\mu\text{V}/\text{div}$ .

**FIGURE 20.**

**Test A03** is an LM741. It, too has significant thermal errors. Note that the left-side hump is larger than the right-hand hump, indicating that the output transistor that sinks current has more thermal effect than the one that sources.

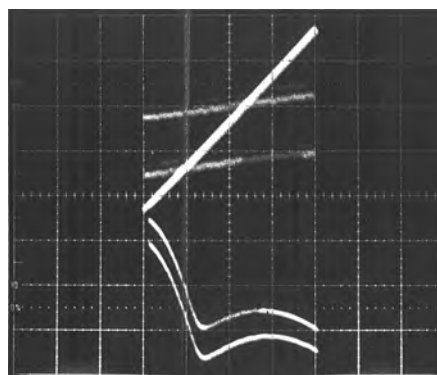

20194924

Test A03, LM741,  $F = 2$  Hz

$V_S = \pm 15$  Vdc;  $V_{out} = \pm 10$  volts peak,  $I_{out} = \pm 10$  mA Peak.

Upper Trace: Gain Error, No Load,  $+9\mu\text{V}$  p-p at  $20\mu\text{V}/\text{div}$ .

Lower Trace: Gain Error, Full Load,  $120\mu\text{V}$  p-p at  $50\mu\text{V}/\text{div}$ .

**FIGURE 21.**

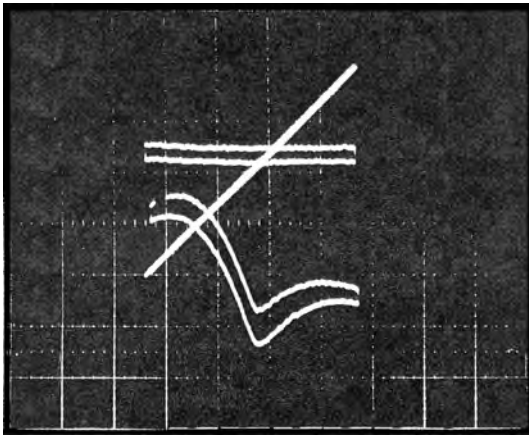

20194925

Test A03B, LM741,  $F = 1$  Hz.  
 $V_S = \pm 15$  Vdc;  $V_{out} = \pm 10$  volts peak,  $I_{out} = \pm 10$  mA peak.  
 Upper Trace: Gain Error, No Load,  $20\mu\text{V}$  p-p at  $50\mu\text{V}/\text{div}$ .  
 Lower Trace: Gain Error, Full Load,  $120\mu\text{V}$  p-p at  $50\mu\text{V}/\text{div}$ .

FIGURE 22.

**Test A04** is the old LM725, not based on the Fairchild  $\mu\text{A}725$ . This amplifier had much lower thermal errors than the amplifiers we have seen so far, reflecting an improved layout. This was a 3-stage amplifier with much higher dc gain, about 2 million at no load, and 1.8 million even at full load. However, this design had a large die, was expensive, was hard to provide with damping components, and was never popular. But it did have improved linearity and low thermal errors.

**NOTE** that the frequency response caused the p-p dynamic error to be about  $5\mu\text{V}$  p-p larger at the right-hand side, than at the left. This is because the LM725 was damped largely by diode capacitances, rather than by discrete damping capacitors. The capacitance was larger when the output voltage was positive. It is also noticeable to see the little blip as the output has a bit of cross-over distortion at 0 volts. Still, we are only seeing these tiny errors (with a resolution of about  $2\mu\text{V}$ ) because this amplifier's gain and noise are better than most of the previous amplifiers. At moderate loads such as 4 k ohms, it was capable of about 0.1 ppm linearity.

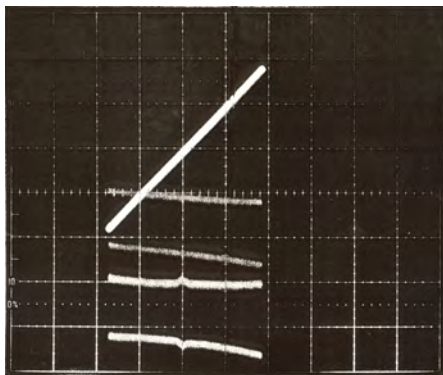

20194926

Test A04, LM725\*,  $F = 75$  Hz.  
 $V_S = \pm 15$  Vdc;  $V_{out} = \pm 9$  volts peak,  $I_{out} = \pm 9$  mA peak.  
 Upper Trace: Gain Error, No Load,  $10\mu\text{V}$  p-p at  $20\mu\text{V}/\text{div}$ .  
 Lower Trace: Gain Error, Full Load,  $11\mu\text{V}$  p-p at  $20\mu\text{V}/\text{div}$ .

FIGURE 23.

**Test A05** is the old LM308. Its thermal errors hump up on one side, and down on the other side, indicating that the thermal errors couple into the input stage differently for outputs sourcing vs. sinking currents. This, too, is down near 1 or 2 ppm of error. However, the LM308 was only rated for a 2 mA load, and this unit was run at just 5 mA, as it could not drive a 1k resistive load.

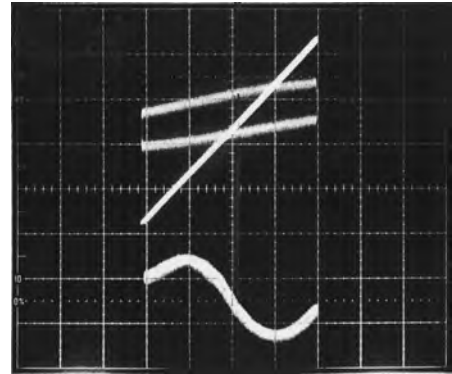

20194927

Test A05, LM308,  $F = 100$  Hz.  
 $V_S = \pm 15$  Vdc;  $V_{out} = \pm 10$  volts peak,  $I_{out} = \pm 5$  mA peak. ( $R_L = 2$  k)  
 Upper Trace: Gain Error, No Load,  $40\mu\text{V}$  p-p at  $50\mu\text{V}/\text{div}$ .  
 Lower Trace: Gain Error, Full Load,  $80\mu\text{V}$  p-p at  $50\mu\text{V}/\text{div}$ . ( $F = 2$  Hz)

FIGURE 24.

**Test A05B** is an older LM308. We don't know how old -- perhaps 25 or 30 years -- but this shows that the chip layout was quite different, with a distinctly different thermal signature, compared to Test A05. The total thermal error is not much better than A05, but it sure is different! Robert Widlar made many experiments of different layouts. Most amplifier designers made one layout, but Widlar knew that it was important to try different layouts, as layout is such an important factor in amplifier performance.

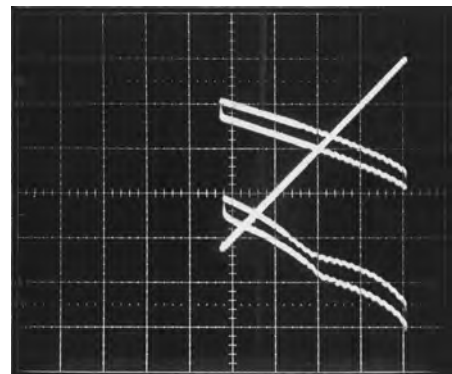

20194928

Test A05B, LM308, OLD,  $F = 4$  Hz.  
 $V_S = \pm 15$  Vdc;  $V_{out} = \pm 10$  volts peak,  $I_{out} = \pm 10$  mA peak.  
 Upper Trace: Gain Error, No Load,  $160\mu\text{V}$  p-p at  $100\mu\text{V}/\text{div}$ .  
 Lower Trace: Gain Error, Full Load,  $260\mu\text{V}$  p-p at  $100\mu\text{V}/\text{div}$ .

FIGURE 25.

**Test A06** is the old LM318. This is not a perfect design, and not a very good thermal layout, but it was very fast, and ran rather rich, and hot, and its mediocre thermal errors are acceptable compared to general-purpose amplifiers.

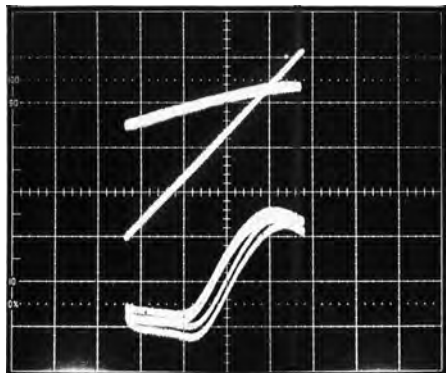

20194929

Test A06, LM318,  $F = 10$  Hz.  
 $V_S = \pm 15$  Vdc;  $V_{out} = \pm 10$  volts peak,  $I_{out} = \pm 10$  mA peak.  
 Upper Trace: Gain Error, No Load,  $+ 40\mu\text{V}$  p-p at  $50\mu\text{V}/\text{div}$ .  
 Lower Trace: Gain Error, Full Load,  $+ 125\mu\text{V}$  p-p at  $50\mu\text{V}/\text{div}$ .

FIGURE 26.

**Test A07** is an NSC OP-07. Its thermal errors are not appreciably better than normal.

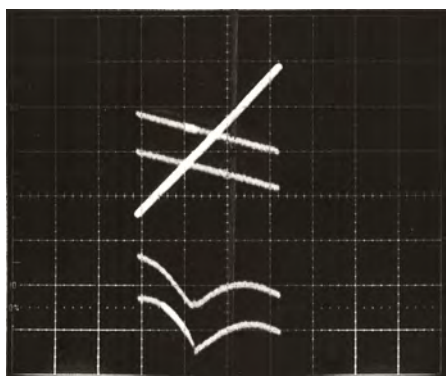

20194930

Test A07, OP-07\*,  $F = 1.2$  Hz.  
 $V_S = \pm 15$  Vdc;  $V_{out} = \pm 7.5$  volts peak,  $I_{out} = \pm 7.50$  mA peak.  
 Upper Trace: Gain Error, No Load,  $18\mu\text{V}$  p-p at  $20\mu\text{V}/\text{div}$ .  
 Lower Trace: Gain Error, Full Load,  $26\mu\text{V}$  p-p at  $20\mu\text{V}/\text{div}$ .

FIGURE 27.

**Test A08** is the LF411, with BiFET (TM) input FETs. It used a very complicated layout, that did not work especially well, in terms of gain or thermals. No better than average.

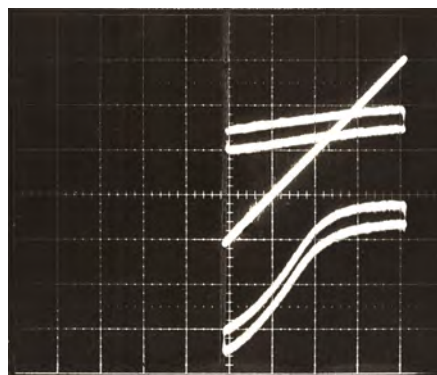

20194931

Test A08, LF411,  $F = 6$  Hz.  
 $V_S = \pm 15$  Vdc;  $V_{out} = \pm 10$  volts peak,  $I_{out} = \pm 10$  mA peak.  
 Upper Trace: Gain Error, No Load,  $+ 24\mu\text{V}$  p-p at  $50\mu\text{V}/\text{div}$ .  
 Lower Trace: Gain Error, Full Load,  $+ 140\mu\text{V}$  p-p at  $50\mu\text{V}/\text{div}$ .

FIGURE 28.

**Test A09** was the older LF356 BiFET amplifier. It had a unique and proprietary output stage, that worked just so-so. It did provide adequate output impedance at 4 MHz, so it was a little faster than most of the general-purpose amplifiers. But its nonlinearity was only average.

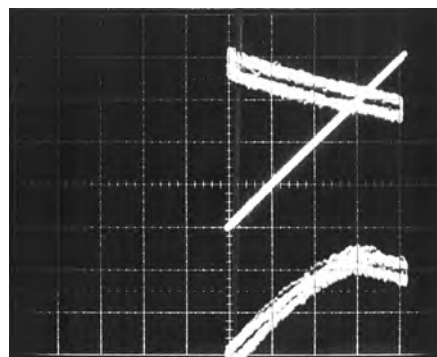

20194932

Test A09, LF356,  $F = 6$  Hz.  
 $V_S = \pm 15$  Vdc;  $V_{out} = \pm 10$  volts peak,  $I_{out} = \pm 10$  mA peak.  
 Upper Trace: Gain Error, No Load,  $55\mu\text{V}$  p-p at  $50\mu\text{V}/\text{div}$ .  
 Lower Trace: Gain Error, Full Load,  $+ 130\mu\text{V}$  p-p at  $50\mu\text{V}/\text{div}$ .

FIGURE 29.

**Test A10** is the LM607. At one time it was the ~ best op amp in the world, but it was discontinued as no customers ever found out about it. Its non-linearity is down at the 0.2 ppm level. The distortion does not look so good, only because the gain is turned up twice as high as ~ any previous amplifier. I used to think the LM607 had a perfect design and layout, but it does seem to show a couple microvolts of thermal error, mostly on the positive side, when sourcing current. This could easily lead to a nonlinearity of 0.15 ppm.

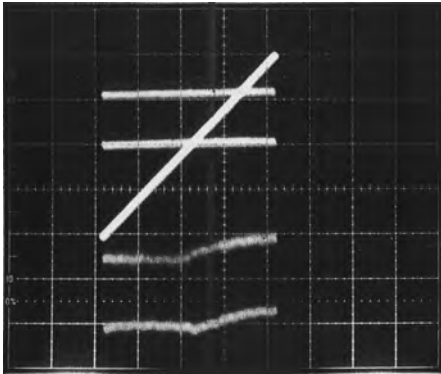

20194933

Test A10, LM607\*,  $F = 3$  Hz.  
 $V_S = \pm 15$  Vdc;  $V_{out} = \pm 10$  volts peak,  $I_{out} = \pm 10$  mA peak.  
 Upper Trace: Gain Error, No Load,  $+ 1\mu\text{V}$  p-p at  $10\mu\text{V}/\text{div}$ .  
 Lower Trace: Gain Error, Full Load,  $+ 5\mu\text{V}$  p-p at  $10\mu\text{V}/\text{div}$ .

**FIGURE 30.**

**Test A11**, the LM627, was a similar design to the LM607, but the layout must have gotten lucky, and the thermal errors are down below 1 microvolt, even at the heavy load. I must admit, I am not sure why the gain tends to go from (+ 10 million) at no load, to (+ 4 million) at full load. Adding a heavy load does not usually cause the gain to go more (positive). This amplifier also was not well promoted, was not well known, and was discontinued.

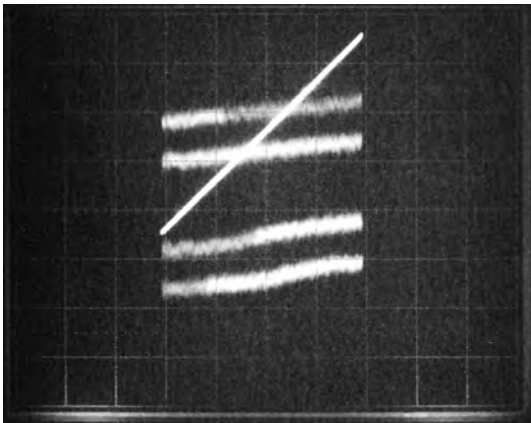

20194970

Test A11, LM627\*,  $F = 8$  Hz.  
 $V_S = \pm 15$  Vdc;  $V_{out} = \pm 10$  volts peak,  $I_{out} = \pm 10$  mA peak.  
 Upper Trace: Gain Error, No Load,  $2\mu\text{V}$  p-p at  $10\mu\text{V}/\text{div}$ .  
 Lower Trace: Gain Error, Full Load,  $+ 5\mu\text{V}$  p-p at  $10\mu\text{V}/\text{div}$ .

**FIGURE 31.**

**Test A12** is the LM10. As mentioned earlier, this is the first amplifier with a "rail-to-rail" output. This amplifier met many dc characteristics with miraculous accuracy, but the ac linearity was NOT quite as good as you would expect from Widlar. Later, Widlar's LM12 showed that he could do excellent accuracy for dynamic errors and linearity, but the LM10 was primarily a DC amplifier. Its errors look "pretty bad", but actually its non-linearity was no worse than general-purpose amplifiers -- barely 1 or 2 ppm. Its cross-over distortion was NOT very good, even at 1 Hz, and at higher frequencies, it is not good at all. The LM10 was NOT a good, linear audio amplifier.

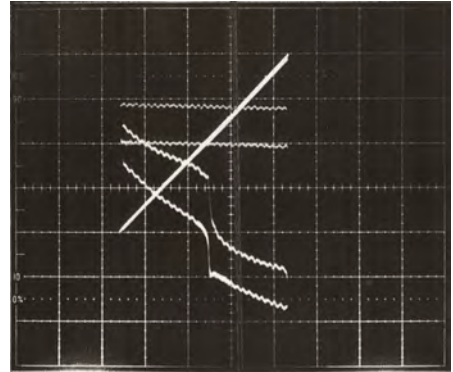

20194935

Test A12, LM10,  $F = 1$  Hz.  
 $V_S = \pm 15$  Vdc;  $V_{out} = \pm 10$  volts peak,  $I_{out} = \pm 10$  mA peak.  
 Upper Trace: Gain Error, No Load,  $4\mu\text{V}$  p-p at  $20\mu\text{V}/\text{div}$ .  
 Lower Trace: Gain Error, Full Load,  $170\mu\text{V}$  p-p at  $50\mu\text{V}/\text{div}$ .

**FIGURE 32.**

**Test A13** shows an LM10 running slightly faster, at 10 Hz. If you look at the lower trace, done with a sine wave, it looks very distorted and confusing, and it is hard to see what is going on. The upper trace shows the error using a triangle wave. This looks just like a speeded up version of the curve at Test A12. This is one of the major reasons we prefer using triangle waves, rather than sines -- so we can see and understand what is going on.

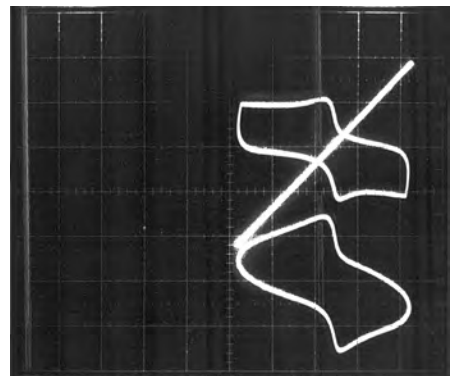

20194936

Test A13, LM10,  $F = 10$  Hz.  
 $V_S = \pm 15$  Vdc;  $V_{out} = \pm 10$  volts peak,  $I_{out} = \pm 10$  mA peak.  
 Upper Trace: Gain Error, No Load,  $230\mu\text{V}$  p-p at  $100\mu\text{V}/\text{div}$ ., TRIANGLE wave.  
 Lower Trace: Gain Error, Full Load,  $290\mu\text{V}$  p-p at  $100\mu\text{V}/\text{div}$ ., SINE wave.

**FIGURE 33.**

**Test A14** shows an LM307, a version of the LM301 with a 30 pF compensation capacitor built in. This re-layout caused somewhat different thermal errors. The distortion is about typical for general-purpose amplifiers.

This completes the study of single high-voltage amplifiers.

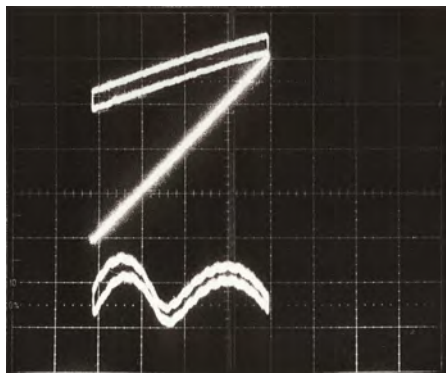

20194937

Test A14, LM307J,  $F = 2 \text{ Hz}$ .

$V_S = \pm 15 \text{ Vdc}$ ;  $V_{out} = \pm 10 \text{ volts peak}$ ,  $I_{out} = \pm 10 \text{ mA peak}$ .

Upper Trace: Gain Error, No Load,  $+ 55 \mu\text{V p-p}$  at  $50 \mu\text{V/div}$ .

Lower Trace: Gain Error, Full Load,  $60 \mu\text{V p-p}$  at  $50 \mu\text{V/div}$ .

**FIGURE 34.**

## Section B, High-Voltage ( $\pm 15V$ ) DUAL Amplifiers

**Test B01**, the LM358, is the dual version of the LM324. No study of amplifiers would be complete without a mention of the pioneering LM324/LM358. This is the first amplifier whose honest gain is so non-linear. That is because the output stage has a Darlington to source the output current, but only one vertical PNP to drive the sinking current. So it really is deficient in gain, for negative currents. The DC distortion is STILL at the 1.5 ppm level. But the thermal errors are negligible.

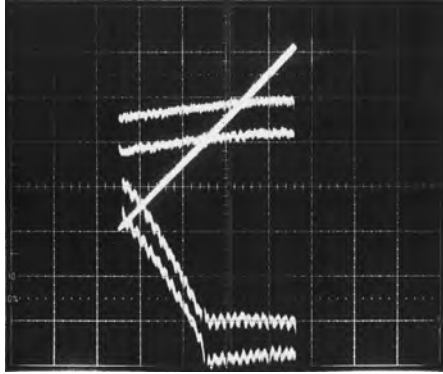

Test B01, LM358,  $F = 1.5$  Hz. 20194938  
 $V_S = \pm 15$  Vdc;  $V_{out} = \pm 10$  volts peak,  $I_{out} = \pm 10$  mA peak.  
 Upper Trace: Gain Error, No Load,  $+ 10\mu V$  p-p at  $20\mu V/div$ .  
 Lower Trace: Gain Error, Full Load,  $65\mu V$  p-p at  $20\mu V/div$ .

**FIGURE 35.**

LM324s really are used for audio amplifiers and preamps. But who would use an amplifier with poor linearity like that for an audio amplifier? It's easy: the output of the amplifier gets a pre-load or pull-down resistor, such as 5 k from the output to the - supply, so the output voltage can swing up and down a couple volts, but the output current is only sourcing. This provides very adequate linearity for small signals. The LM324 or LM358 can only swing a couple volts at 10 kHz, but that is adequate for preamps.

**Test B02** is an LF412, a dual version of the LF411. Despite strenuous efforts to make a good layout, its thermal errors are only a little better than average (about 1/4 ppm).

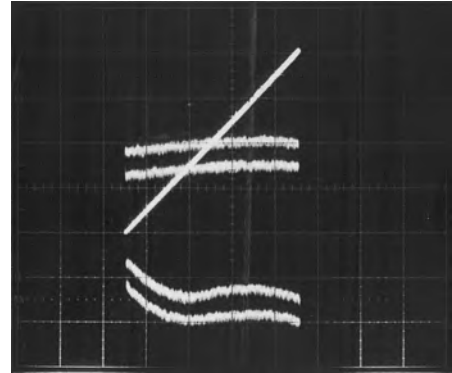

Test B02, LF412,  $F = 4$  Hz. 20194939  
 $V_S = \pm 15$  Vdc;  $V_{out} = \pm 10$  volts peak,  $I_{out} = \pm 10$  mA peak.  
 Upper Trace: Gain Error, No Load,  $+ 5\mu V$  p-p at  $20\mu V/div$ .  
 Lower Trace: Gain Error, Full Load,  $15\mu V$  p-p at  $20\mu V/div$ .

**FIGURE 36.**

**Test B03** is the LF442, a low-power version of the LF412. It was not rated to drive more than 2 mA, and driving 5 mA did cause poor gain, hundreds of microvolts of gain error, and not very linear. When driving light loads, less than 1 mA, the LF442 was a good general-purpose amplifier.

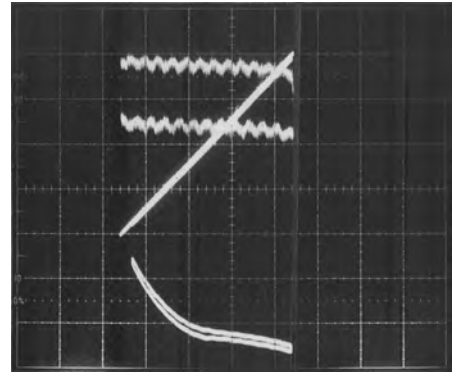

Test B03, LF442,  $F = 2$  Hz. 20194940  
 $V_S = \pm 15$  Vdc;  $V_{out} = \pm 10$  volts peak,  $I_{out} = \pm 10$  mA peak.  
 Upper Trace: Gain Error, No Load,  $6\mu V$  p-p at  $20\mu V/div$ .  
 Lower Trace: Gain Error, Full Load,  $380\mu V$  p-p at  $200\mu V/div$ .

**FIGURE 37.**

**Test B04** is the LM833, an amplifier optimized for audio applications. It has reasonably good linearity, under rated conditions but is not able to drive more than the over-load of  $-8$  mA without some distortion.

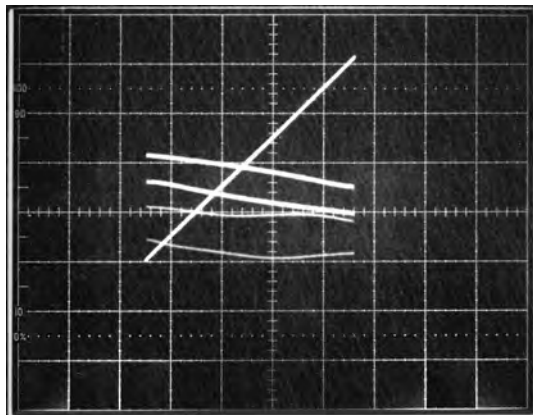

20194963

Test B04, LM833,  $F = 10$  Hz.  
 $V_S = \pm 15$  Vdc;  $V_{out} = \pm 10$  volts peak,  $I_{out} = \pm 8$  mA peak.  
 Upper Trace: Gain Error, No Load,  $6\mu\text{V}$  p-p at  $20\mu\text{V}/\text{div}$ .  
 Lower Trace: Gain Error, Full Load,  $380\mu\text{V}$  p-p at  $200\mu\text{V}/\text{div}$ . ( $R_L = 2\text{k}$ )

FIGURE 38.

**Test B05** is another general-purpose amplifier, the LM1458, basically, a dual LM741. Its errors are only a little worse than typical.

Note that the humps are upside down, compared to most of the other amplifiers. This just means the heat-sensing inputs are arranged to detect the thermal gradients in the reverse sense.

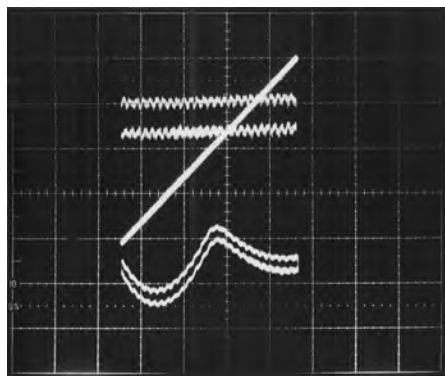

20194941

Test B05, LM1458,  $F = 1.1$  Hz.  
 $V_S = \pm 15$  Vdc;  $V_{out} = \pm 10$  volts peak,  $I_{out} = \pm 10$  mA peak.  
 Upper Trace: Gain Error, No Load,  $+3\mu\text{V}$  p-p at  $20\mu\text{V}/\text{div}$ .  
 Lower Trace: Gain Error, Full Load,  $70\mu\text{V}$  p-p at  $50\mu\text{V}/\text{div}$ .

FIGURE 39.

**Test B06** is an LM6182, and its gain errors are quite large - the voltage gain is just 2,500, and the gain error degrades 1 millivolt with the 1k load. Its  $g_m$  is only 20 mhos. Who would be interested in an amplifier with such mediocre gain? It's not even as good gain as an old LM709!

The answer is, the LM6182 is quite fast. Its distortion at DC is not great, but the distortion holds low even up to 10 MHz ( $-50$  dBc). So while we would not say it is a good general-purpose amplifier, it actually is a fairly popular amplifier for high-speed applications. This is one of the first current-mode amplifiers we have seen.

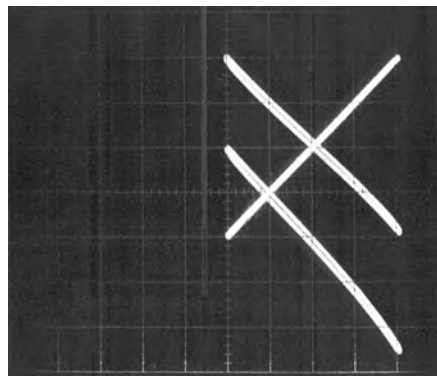

20194942

Test B06, LM6182,  $F = 500$  Hz.  
 $V_S = \pm 15$  Vdc;  $V_{out} = \pm 10$  volts peak,  $I_{out} = \pm 10$  mA peak.  
 Upper Trace: Gain Error, No Load,  $7.8$  mV p-p at  $2$  mV/div.  
 Lower Trace: Gain Error, Full Load,  $8.8$  mV p-p at  $2$  mV/div.

FIGURE 40.

**Test B07** is the LM6142, a rail-to-rail amplifier. We don't expect its gain to not change with load - and its gain DOES change with load. But its voltage gain falls from just 3 million to 1/4 million. Its nonlinearity is still about average, with a 1k load. Note that its cross-over distortion is MUCH improved over the LM10 (Test A12). This amplifier, running on less than 0.7 mA per channel, has a 17 MHz gain-bandwidth product, much improved over the slow LM10.

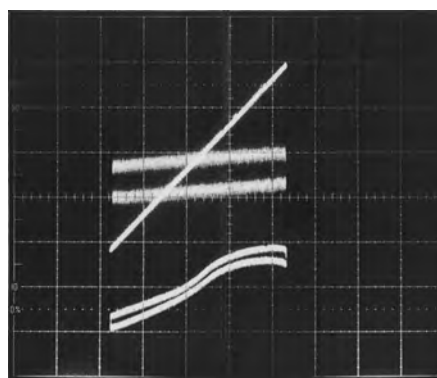

20194943

Test B07, LM6142,  $F = 20$  Hz.  
 $V_S = \pm 15$  Vdc;  $V_{out} = \pm 10$  volts peak,  $I_{out} = \pm 5$  mA peak.  
 Upper Trace: Gain Error, No Load,  $+7\mu\text{V}$  p-p at  $20\mu\text{V}/\text{div}$ .  
 Lower Trace: Gain Error, Full Load,  $80\mu\text{V}$  p-p at  $50\mu\text{V}/\text{div}$ . ( $R_L = 2\text{k}$ )

FIGURE 41.

**Test B08** is the LM6152, a faster 75 MHz amplifier, which also is a "rail-to-rail" Test. Its nonlinearity at 1k load (middle trace) is mediocre, but at its rated 2k load (lower trace) its linearity is well below 1 ppm.

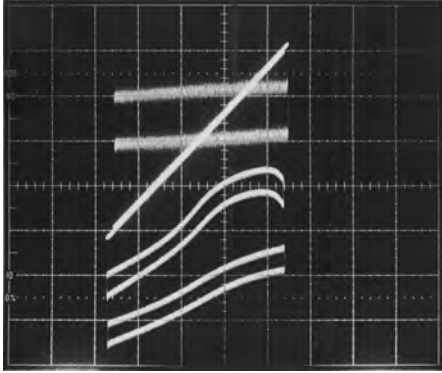

20194944

Test B08, LM6152,  $F = 100 \text{ Hz}$ .  
 $V_S = \pm 15 \text{ Vdc}$ ;  $V_{out} = \pm 10 \text{ volts peak}$ ,  $I_{out} = \pm 5 \text{ mA peak}$ .  
 Upper Trace: Gain Error, No Load,  $-7\mu\text{V p-p}$  at  $20\mu\text{V/div}$ .  
 Middle Trace: Gain Error,  $\pm 10 \text{ mA Load}$ ,  $120\mu\text{V p-p}$  at  $50\mu\text{V/div}$ .  
 Lower Trace: Gain Error,  $\pm 5 \text{ mA Load}$ ,  $76\mu\text{V p-p}$  at  $50\mu\text{V/div}$ .

FIGURE 42.

**Test B09** is the LM8262, another fast amplifier. Its gain is high at no-load, but the gain falls to 2700 at the 1k load. The crossover distortion is not very good, either. But it is fast. Also, it is tolerant of capacitive loads.

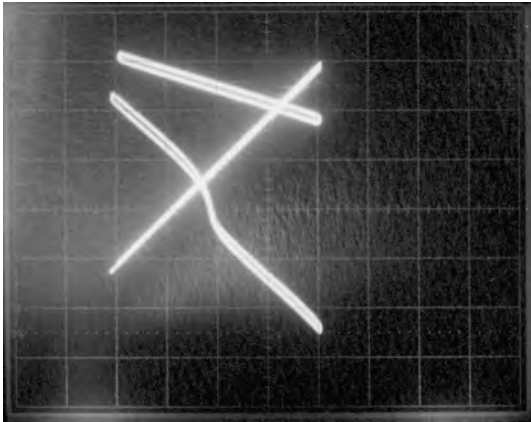

20194964

Test B09, LM8262  $F = 200\text{Hz}$ .  
 $V_S = \pm 11 \text{ Vdc}$ ;  $V_{out} = \pm 10 \text{ volts peak}$ ,  $I_{out} = \pm 10 \text{ mA peak}$ .  
 Upper Trace: Gain Error, No Load,  $1.3\mu\text{V p-p}$  at  $1\text{mV/div}$ .  
 Lower Trace: Gain Error, Full Load,  $4.8\text{mV p-p}$  at  $1\text{mV/div}$ .

FIGURE 43.

In **Test B10**, we have "saved the best for last". This precision amplifier, the LME49720, (also known as an LM4562) not only tests good, but it sounds good. The distortion is not only down somewhere below 0.15 ppm at 25 Hz, but it keeps improving at frequencies up to 1 kHz. It was designed as a precision audio amplifier, but is well suited for many other precision op-amp functions, with the best, lowest distortion in the industry. As you can plainly see, the thermals found in most other bipolar transistor op-amps have been banished by excellent layout. Distortion as low as -159 dB has been observed as an inverter, even driving a 2 kilohm load. For a study of how to test an op-amp with such low distortion at 1 kHz, refer to AN-1671.

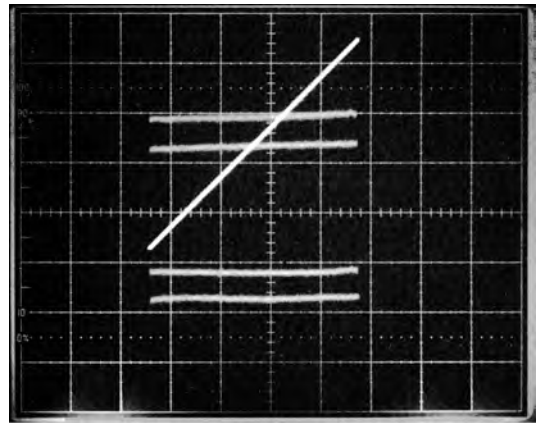

20194965

Test B10, LM4562 (also known as LME49720)  $F = 25 \text{ Hz}$ .  
 $V_S = \pm 15 \text{ Vdc}$ ;  $V_{out} = \pm 10 \text{ volts peak}$ ,  $I_{out} = \pm 10 \text{ mA peak}$ .  
 Upper Trace: Gain Error, No Load,  $+1.5\mu\text{V p-p}$  at  $10\mu\text{V/div}$ .  
 Lower Trace: Gain Error, Full Load,  $1.5\mu\text{V p-p}$  at  $10\mu\text{V/div}$ .

FIGURE 44.

## Group C: Single CMOS Op-Amps

I did not include or test any of these; I tested the more popular dual amplifiers.



## Group D: Dual CMOS Op-Amps

These are all rated to run on  $\pm 7.5$  volts. I operated them on  $\pm 5.0$  volts, and I required them to drive a 1 kilohm load to  $\pm 4$  volts.

**Test D01** is the basic old LMC662, a dual version of the LMC660, NSC's first CMOS amplifier. Its gain error looks quite non-linear; however, it is really not bad. The peak error is  $27\mu\text{V}$  p-p, and the p-p nonlinear error is about  $13\mu\text{V}$  p-p. If tested with a 4k load, it would have a nonlinearity of better than 1 ppm (as a unity-gain inverter, for example). The designer, Dennis Monticelli, pointed out that this amplifier design has 3 honest gain stages for sinking current (left side of the trace) but 4 stages of gain for sourcing current (right side of the trace). Since gain for sourcing current is usually considered more important, he let the design go as "plenty good enough". I tend to agree that a linearity of 1 ppm is "plenty good enough" for any general-purpose amplifier.

Here is an amplifier where the output impedance really is high. When the load is lightened from 1k to 2k, 4k, 8k, etc., the gain keeps going up. How high does it go? It's almost impossible to resolve how high the gain goes, or how high the output impedance is. The gain goes up by AT LEAST a factor of 30, and quite possibly 60 or more. So the output impedance goes up to at least 30k, and maybe 100 or 200k. Is the exact number important? Is it important if the gain goes up to 4 million, or 8 million? In theory, it is fun to imagine that a gain of 4 million is not quite as good as 8 million. Or that if the gain goes up to 8 million, then the low-frequency gain roll-off starts falling from the DC gain of 8 million at 0.1 Hz. But as you can see, these amplifiers are well-behaved, and the loop is obviously stable for all conditions. If you only looked at the left-hand side ( $V_{\text{out}} = \text{negative}$ ) where the output is sinking load current, the gain may be finite, but this amplifier is very well behaved. Likewise on the right-hand side, it is a very high-gain amplifier -- and very well behaved. If the amplifier runs anywhere in the middle, or on either end -- the amplifier is STILL very well-behaved. It just has a small bit of nonlinearity. We don't usually think of 1 ppm as a significant amount of non-linearity -- but that is the only thing wrong with this amplifier! We are discussing this at great length, primarily because it shows that very high gain, whether at no load or at heavy load, does not cause any problems. Also because several other CMOS amplifiers have very similar characteristics.

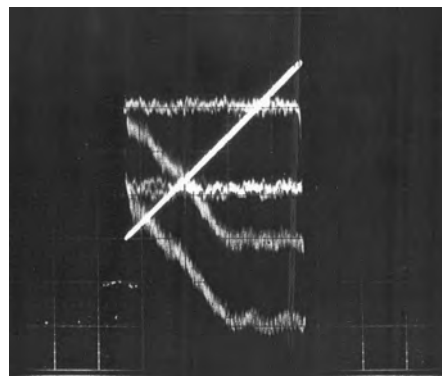

20194901

Test D01, LMC662,  $F = 6$  Hz.  
 $V_S = \pm 5$  Vdc;  $V_{\text{out}} = \pm 4$  volts peak,  $I_{\text{out}} = \pm 4$  mA peak.  
 Upper Trace: Gain Error, No Load,  $1\mu\text{V}$  p-p at  $10\mu\text{V}/\text{div}$ .  
 Lower Trace: Gain Error, Full Load,  $27\mu\text{V}$  p-p at  $10\mu\text{V}/\text{div}$ .

**FIGURE 45.**

The traces on **D01B** are for the same amplifier. In the top-most trace, a 500 pF filter capacitor is added across the 1 megohm gain-setting resistor in *Figure 7*, to cut the noise a little. The middle trace shows how noisy this set-up was, when I neglected to ground the operator's body while pushing the shutter button! The standard noise was on the lower trace. Note that even though these traces seem noisy, the noise is barely 3 or 4  $\mu\text{V}$  p-p, and the gain errors as large as 1 or 2  $\mu\text{V}$  can be resolved, nicely.

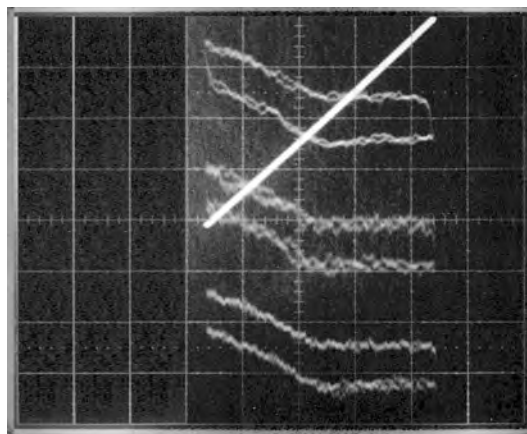

20194902

Test D01B, LMC662,  $F = 6$  Hz.  
 Upper Trace: Gain Error, Full Load,  $27\mu\text{V}$  p-p at  $20\mu\text{V}/\text{div}$ .,  $C = 500\text{pF}$ .  
 Middle Trace: Gain Error, Full Load,  $27\mu\text{V}$  p-p at  $20\mu\text{V}/\text{div}$ ., with 60 Hz Ambient Noise..  
 Lower Trace: Gain Error, Full Load,  $27\mu\text{V}$  p-p at  $20\mu\text{V}/\text{div}$ ., Normal Test.

**FIGURE 46.**

**Test D02** is a LMC6492, a standard CMOS amplifier similar to the LMC6482, with rail-to-rail inputs and output, rated from -40 to + 125 degrees C.

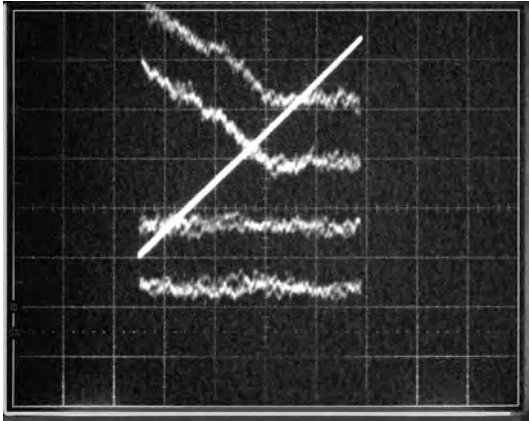

20194971

Test D02, LMC6492,  $F = 6 \text{ Hz}$ .  
 $V_S = \pm 5 \text{ Vdc}$ ;  $V_{out} = \pm 4 \text{ volts peak}$ ,  $I_{out} = \pm 4 \text{ mA peak}$ .  
 Upper Trace: Gain Error, No Load,  $1 \mu\text{V p-p}$  at  $10 \mu\text{V/div}$ .  
 Lower Trace: Gain Error, Full Load,  $22 \mu\text{V p-p}$  at  $10 \mu\text{V/div}$ .

FIGURE 47.

**Test D03** is a standard CMOS amplifier, the LMC6482, similar to LMC6492, rated from -40 to +85 degrees C. Its gain curves are - typical.

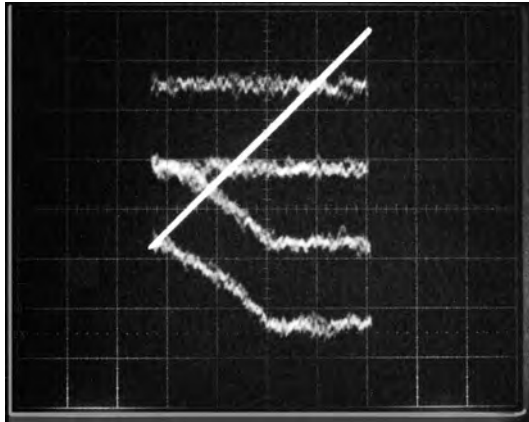

20194972

Test D03, LMC6482,  $F = 6 \text{ Hz}$ .  
 $V_S = \pm 5 \text{ Vdc}$ ;  $V_{out} = \pm 4 \text{ volts peak}$ ,  $I_{out} = \pm 4 \text{ mA peak}$ .  
 Upper Trace: Gain Error, No Load,  $1 \mu\text{V p-p}$  at  $10 \mu\text{V/div}$ .  
 Lower Trace: Gain Error, Full Load,  $18 \mu\text{V p-p}$  at  $10 \mu\text{V/div}$ .

FIGURE 48.

**Test D05A** is a micropower amplifier, the LMC6572, drawing just  $40 \mu\text{A}$  of current. Even though it is running very lean, internally, it can drive a  $\pm 4 \text{ mA}$  load with a gain over 1 million, and a nonlinearity better than  $0.2 \text{ ppm}$ . It is characterized down to  $2.7 \text{ volts}$  of power supply.

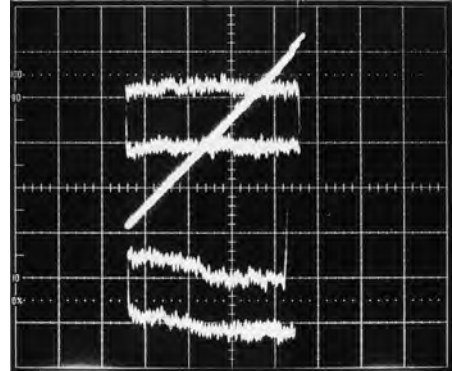

20194904

Test D05A, LMC6572,  $F = 0.8 \text{ Hz}$ .  
 $V_S = \pm 5 \text{ Vdc}$ ;  $V_{out} = \pm 4 \text{ volts peak}$ ,  $I_{out} = \pm 4 \text{ mA peak}$ .  
 Upper Trace: Gain Error, No Load,  $2 \mu\text{V p-p}$  at  $10 \mu\text{V/div}$ .  
 Lower Trace: Gain Error, Full Load,  $5 \mu\text{V p-p}$  at  $10 \mu\text{V/div}$ .

FIGURE 49.

**Test D06A** is an LMC6042, another micropower amplifier, running on just  $10 \mu\text{A}$ . Its gain and linearity are about as good as the previous example, with a gain over 1 million and gain linearity below  $0.2 \text{ ppm}$ . It is only rated to run from + 15 volts down to + 5 volts of total power supply.

**Test D06B** is another LMC6042.

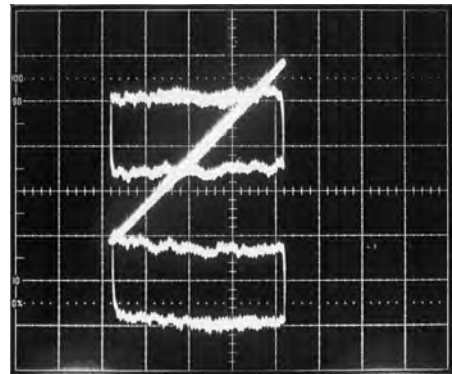

20194905

Test D06A, LMC6042,  $F = 0.6 \text{ Hz}$ .  
 $V_S = \pm 5 \text{ Vdc}$ ;  $V_{out} = \pm 4 \text{ volts peak}$ ,  $I_{out} = \pm 4 \text{ mA peak}$ .  
 Upper Trace: Gain Error, No Load,  $2 \mu\text{V p-p}$  at  $20 \mu\text{V/div}$ .  
 Lower Trace: Gain Error, Full Load,  $6 \mu\text{V p-p}$  at  $20 \mu\text{V/div}$ .

FIGURE 50.

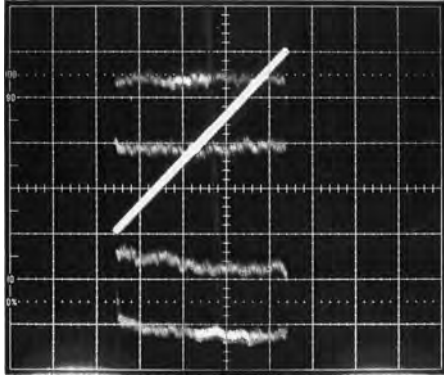

20194906

Test D06B, LMC6042,  $F = 0.6 \text{ Hz}$   
 $V_S = \pm 5 \text{ Vdc}$ ;  $V_{out} = \pm 4 \text{ volts peak}$ ,  $I_{out} = \pm 4 \text{ mA peak}$ .  
 Upper Trace: Gain Error, No Load,  $3\mu\text{V p-p}$  at  $20\mu\text{V/div}$ .  
 Lower Trace: Gain Error, Full Load,  $6\mu\text{V p-p}$  at  $20\mu\text{V/div}$ .

FIGURE 51.

**Test D07B** is another low-power amplifier, requiring less than  $100 \mu\text{A}$  per channel. Its nonlinearity is down below  $0.3 \text{ ppm}$ . As noted earlier, our testing with triangle waves help us resolve non-linearities below  $1 \text{ ppm}$ . If we were testing with sine waves, as in the lower trace, it would be hard to resolve these small sub-ppm errors.

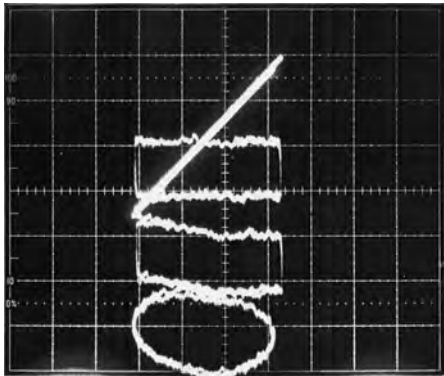

20194907

Test D07B, LMC6022,  $F = 2 \text{ Hz}$ .  
 $V_S = \pm 5 \text{ Vdc}$ ;  $V_{out} = \pm 4 \text{ volts peak}$ ,  $I_{out} = \pm 4 \text{ mA peak}$ .  
 Upper Trace: Gain Error, No Load,  $4\mu\text{V p-p}$  at  $20\mu\text{V/div}$ .  
 Middle Trace: Gain Error, Full Load,  $7\mu\text{V p-p}$  at  $20\mu\text{V/div}$ . (TRIANGLE)  
 Lower Trace: Gain Error, Full Load,  $7\mu\text{V p-p}$  at  $20\mu\text{V/div}$ . (SINE)

FIGURE 52.

**Test D08** is the LMC6062, a precision amplifier with  $V_{os}$  as good as  $350 \mu\text{V}$ , max. Its linearity is down near  $0.2 \text{ ppm}$ .

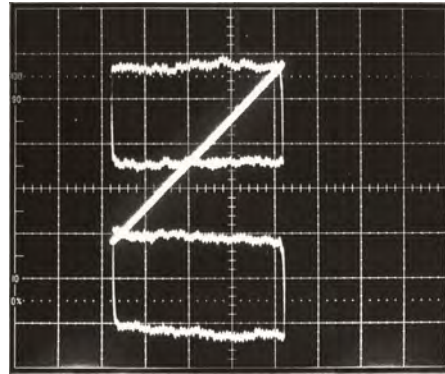

20194908

Test D08, LMC6062,  $F = 0.6 \text{ Hz}$ .  
 $V_S = \pm 5 \text{ Vdc}$ ;  $V_{out} = \pm 3.5, -4.5 \text{ volts peak}$ ,  $I_{out} = 8 \text{ mA p-p}$ .  
 Upper Trace: Gain Error, No Load,  $3\mu\text{V p-p}$  at  $20\mu\text{V/div}$ .  
 Lower Trace: Gain Error, Full Load,  $6\mu\text{V p-p}$  at  $20\mu\text{V/div}$ .

FIGURE 53.

## Group E: Low-Voltage Single Amplifiers ( $\pm 2.5$ -volt Supplies)

**Test E01** is the LMV715, a low-voltage amplifier. Its linearity is as good as 1.5 ppm, 3 $\mu$ V p-p at the input compared to 4 volts p-p of output swing. Of course, at lighter loads, the linearity would improve.

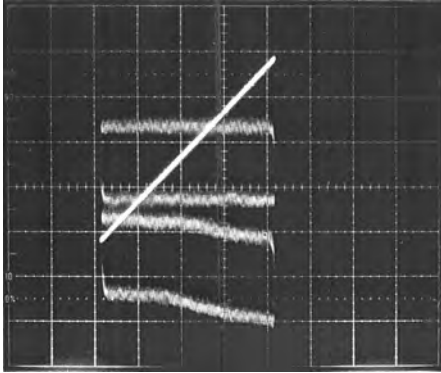

20194910

Test E01, LMV715,  $F = 26$  Hz.  
 $V_S = \pm 2.5$  Vdc;  $V_{out} = \pm 2$  volts peak,  $I_{out} = \pm 2$  mA peak.  
 Upper Trace: Gain Error, No Load, 2 $\mu$ V p-p at 20 $\mu$ V/div.  
 Lower Trace: Gain Error, Full Load, 12 $\mu$ V p-p at 20 $\mu$ V/div.

**FIGURE 54.**

**Test E02** is an LMV751. This amplifier has poorer gain for positive swings (sourcing current). The no-load gain curve (lower trace) is obviously well under 1  $\mu$ V p-p. The linearity with a 4k load would be slightly better than 1 ppm, even though the gain error looks pretty bad! The LMV751 has very low noise, about 6.5 nV per square-root Hertz.

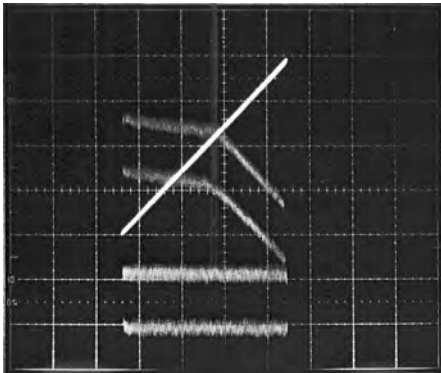

20194911

Test E02, LMV751,  $F = 12$  Hz.  
 $V_S = \pm 2.5$  Vdc;  $V_{out} = \pm 2$  volts peak,  $I_{out} = \pm 2$  mA peak.  
 Upper Trace: Gain Error, Full Load, 11 $\mu$ V p-p at 5 $\mu$ V/div.  
 Lower Trace: Gain Error, No Load, 1 $\mu$ V p-p at 5 $\mu$ V/div.

**FIGURE 55.**

**Test E03** is an LMV771, with mediocre gain in both directions! It looks awful - yet the nonlinearity with a 4k load would be still be better than 1/2 ppm.

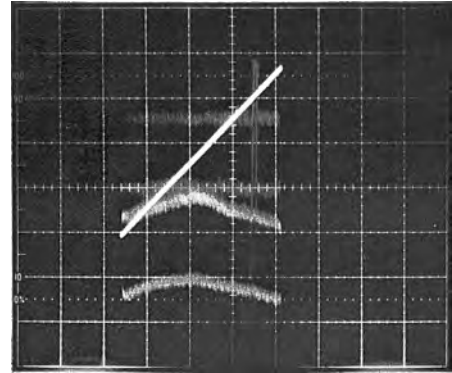

20194912

Test E03, LMV771,  $F = -6$  Hz.  
 $V_S = \pm 2.5$  Vdc;  $V_{out} = \pm 2$  volts peak,  $I_{out} = \pm 2$  mA peak.  
 Upper Trace: Gain Error, No Load, 1 $\mu$ V p-p at 5 $\mu$ V/div.  
 Lower Trace: Gain Error, Full Load, 3 $\mu$ V p-p at 5 $\mu$ V/div.

**FIGURE 56.**

**Test E04** is an LMV301 (bipolar, not CMOS) with very high gain and linearity better than 1/2 ppm.

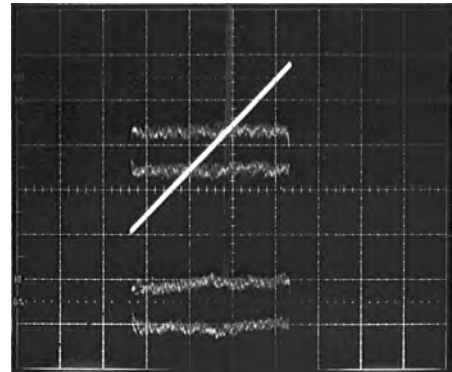

20194913

Test E04, LMV301,  $F = 12$  Hz.  
 $V_S = \pm 2.5$  Vdc;  $V_{out} = \pm 2$  volts peak,  $I_{out} = \pm 2$  mA peak.  
 Upper Trace: Gain Error, No Load, 2 $\mu$ V p-p at 20 $\mu$ V/div.  
 Lower Trace: Gain Error, Full Load, 4 $\mu$ V p-p at 20 $\mu$ V/div.

**FIGURE 57.**

## Group F: Low-Voltage Duals (± 2.5-volt Supplies)

**Test F01A** is the LMP2012, a chopper-stabilized amplifier with gain well over 2 million. The linearity seems to be better than 1/4 ppm. The offset voltage is typically below 4 $\mu$ V.

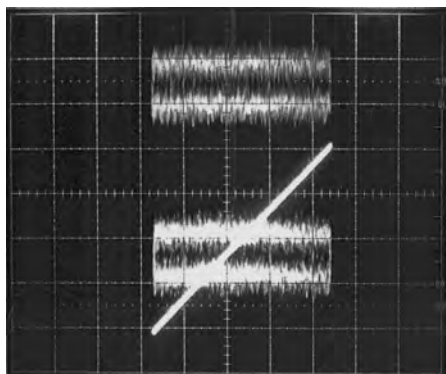

20194914

Test F01A, LMP2012, Side A,  $F = 2$  Hz.  
 $V_S = \pm 2.5$  Vdc;  $V_{out} = \pm 2$  volts peak,  $I_{out} = \pm 2$  mA peak.  
 Upper Trace: Gain Error, No Load, 1 $\mu$ V p-p at 10 $\mu$ V/div.  
 Lower Trace: Gain Error, Full Load, 2 $\mu$ V p-p at 10 $\mu$ V/div.

**FIGURE 58.**

**Trace F01D** is an LMP2012 with the 500 pF filter capacitor added, to help resolve the signals down in the noise; linearity is still below 1/4 ppm.

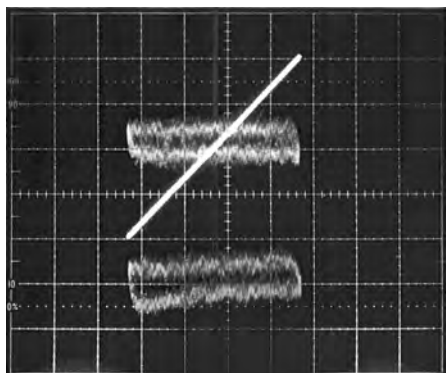

20194915

Test F01D, LMP2012, Side B,  $F = \sim 2$  Hz.  
 $V_S = \pm 2.5$  Vdc;  $V_{out} = \pm 2$  volts peak,  $I_{out} = \pm 2$  mA peak.  
 Upper Trace: Gain Error, No Load, 1 $\mu$ V p-p at 10 $\mu$ V/div.  
 Lower Trace: Gain Error, Full Load, 3 $\mu$ V p-p at 10 $\mu$ V/div.

**FIGURE 59.**

**Test F02** is an LMV932, with 1/4 ppm, most of which is its cross-over distortion.

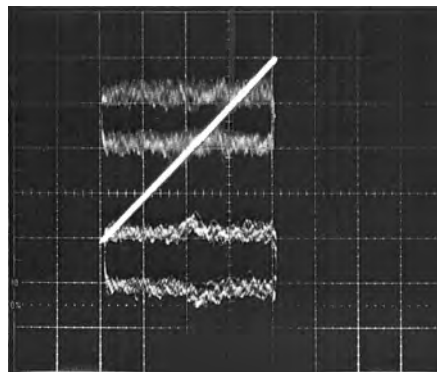

20194916

Test F02, LMV932,  $F = 12$  Hz.  
 $V_S = \pm 2.5$  Vdc;  $V_{out} = \pm 2$  volts peak,  $I_{out} = \pm 2$  mA peak.  
 Upper Trace: Gain Error, No Load, 3 $\mu$ V p-p at 20 $\mu$ V/div.  
 Lower Trace: Gain Error, Full Load, 8 $\mu$ V p-p at 20 $\mu$ V/div.

**FIGURE 60.**

### Test F03

The low-voltage LMV358 does not have the exact same shape of nonlinearity as the LM358 (see test B01, Figure 35) but a somewhat different shape. Its gain is OK, but its non-linearity when driving a 4 kilohm load is about 6 ppm. This is noticeably inferior to many other modern op-amps -- but yet, when do you measure an amplifier with linearity worse than 3 ppm, or complain about it? As with the LM358, the LMV358 can provide excellent linearity if the output has a pre-load (pull-down or pull-up resistor) connected.

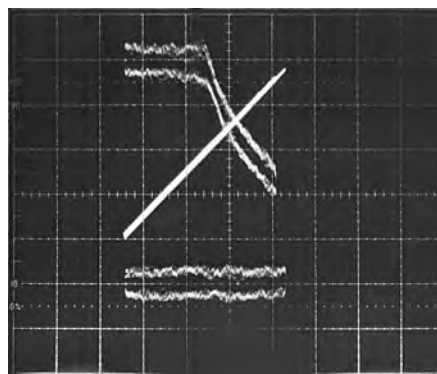

20194917

Test F03, LMV358,  $F = 20$  Hz.  
 $V_S = \pm 2.5$  Vdc;  $V_{out} = \pm 2$  volts peak,  $I_{out} = \pm 2$  mA peak.  
 Upper Trace: Gain Error, Full Load, 150 $\mu$ V p-p at 50 $\mu$ V/div.  
 Lower Trace: Gain Error, No Load, 5 $\mu$ V p-p at 20 $\mu$ V/div.

**FIGURE 61.**

**Test X06** is a very low-voltage amplifier, running on  $\pm 0.45$  volts, with gain error below  $7\mu\text{V}$  p-p, and linearity near 2 ppm.

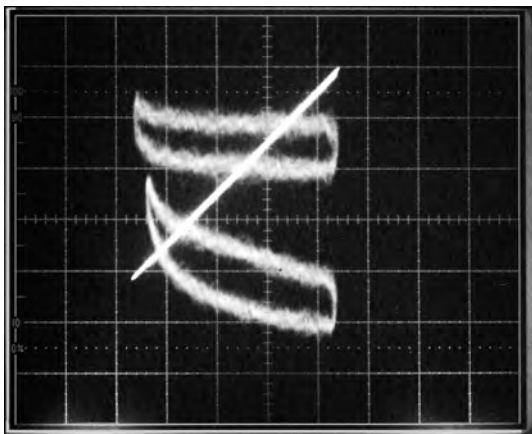

20194973

Test X06, LMV751       $F = 75 \text{ Hz}$ .  
 $V_S = \pm 0.5 \text{ Vdc}$ ;  $V_{out} = \pm 0.4 \text{ volts peak}$ ,  $I_{out} = \pm 0.4 \text{ mA Peak}$ .  
 Upper Trace: Gain Error, No Load,  $7\mu\text{V}$  p-p at  $10\mu\text{V/div}$ .  
 Lower Trace: Gain Error, Full Load,  $20\mu\text{V}$  p-p at  $10\mu\text{V/div}$ .

**FIGURE 62.**

## Conclusions

There are many interesting things to learn about an amplifier's gain, not just one number on a datasheet. Not all amplifiers are the same - or even SIMILAR!! Amplifiers with output followers are not simple to analyze, when thermal errors can cause bigger errors than the gain error. CMOS amplifiers with high output impedance, would seem to have a major source of error at heavy loads, but in actuality, good amplifiers can drive loads with accuracy and linearity much better than 1 ppm. A high output impedance can allow the gain to go extremely high at light loads, and this may be useful in precision applications.

Design Engineers have many things to think about. The gain for positive outputs versus negative outputs may be important for precision amplifiers. Thermal problems may also have to be studied, in areas where computers are not helpful.

Mask Designers have to be concerned with precise placement of critical components. They have to make sure they are given complete instructions on placement and matching.

Applications Engineers have to measure and characterize the new amplifiers, to make sure the characteristics are as good as expected. The data sheet may need to be revised, to show good or bad features of an amplifier's gain.

The Customer does not have to worry so much about the internal design of the amplifier, but he/she may have to be concerned, for critical applications, about some of these features of amplifiers.

## Philosophical Insights

Many engineers have opinions or preconceptions that operational amplifiers made with bipolar transistors have better, higher voltage gain than CMOS amplifiers. Many people have a sense that bipolar op-amps are more linear than CMOS amplifiers. We have showed that this is not exactly true. There are many amplifiers of each Type that are very good -- with linearity better than 0.3 parts per million. Some are barely as good as 2 parts per million -- but at light loads, they can be

used with excellent accuracy and linearity. And of course, many applications do not require linearity better than 1 ppm! Amplifiers are not simple. Silicon is not simple. Understanding circuits is not simple, but it is possible.

## Appendix A: List of Amplifiers with Low and Lower Distortion

The testing of amplifiers in this Applications Note was done on amplifiers that were mostly rated with a 2 kilohm load. I ran most of the tests with a heavy load of 1 kilohm, to make sure I had enough nonlinearity to see a signal.

For this Appendix, the engineering was done for a 10k/10k unity-gain inverter, with a 6.67k load, making a virtual 4 kilohm total load, so the nonlinearity would be done with a moderate load (half the current of the rated 2k load, not double the current). The nonlinearity was sort of interpolated as 1/4 of the nonlinearity with a 1k load. As you will see, many of the amplifiers have surprisingly good linearity, even though the curves with  $RL = 1k$  looked pretty bad. They are listed in order of improving linearity. All data are approximate, and typical. No data are guaranteed. Availability of old amplifier types denoted by \* is not guaranteed, and are very unlikely.

Example: An LM709, per the data shown on Test A01, has a  $100\mu\text{V}$  p-p nonlinear error at its summing point, driving a 1 k load. That is the total p-p deviation from the best-fit straight line. When it is driving 4k of total load, the error would be  $25\mu\text{V}$  p-p, referred to input. The 709's error will be decreased quite strictly by this factor of 4, because it is a thermal error, which heats the input transistors in a highly predictable way.

A unity gain inverter runs at a Noise Gain of 2, so its output would have  $50\mu\text{V}$  p-p. Its output swing is 20 volts p-p. Therefore we will call the distortion, 2.5 ppm, as it is 2.5 ppm of the total output swing. All other amplifiers get the same conversion done for them. It is true that SOME amplifiers will not improve by this transformation, by the exact factor of 4, but it is still approximately correct. The computations were done in terms of p-p errors, as RMS computations would probably not be applicable for such nonlinear signals. If you wanted an LM709 to have better linearity than 2.5 ppm, you could run it with a lighter load, or, choose a better amplifier. Or get a helper amplifier to put out most of the load current.

## Amplifiers with Bipolar Transistors and with $\pm 10$ -Volt output swing (supplies = $\pm 15$ volts)

Type	Test	Nonlinearity
LM8262	(B10B)	12 ppm
LF442	(B03)	8 ppm (light load)
LM6182	(B06)	6 ppm
LM709*	(A01)	2.5 ppm
LM318	(A06)	2.1 ppm
LM741	(A03)	2 ppm
LM301A	(A02)	1.5 ppm
LM10	(A12)	1.5 ppm
LF411	(A08)	1.4 ppm
LM308	(A05)	1.3 ppm
LM1458	(B05)	1.3 ppm
LM307J	(A14)	1.3 ppm
LF356	(A09)	1.2 ppm
LM358N	(B01)	1.0 ppm
LM6142	(B07)	0.5 ppm
OP-07*	(A07)	0.4 ppm
LM833N	(B04)	0.4 ppm
LF412N	(B02)	0.3 ppm
LM6152	(B08)	0.3 ppm
LM607*	(A10)	0.12 ppm
LM725*	(A04)	0.10 ppm
LM627*	(A11)	0.04 ppm
LM4562	(B10)	0.025 ppm

\* Amplifiers denoted by \* are obsolete and are no longer available from NSC.

## CMOS AMPLIFIERS with $\sim$ Rail-to-Rail outputs and with $\pm 4$ -Volt output swing (supplies = $\pm 5$ volts)

Type	Test	Nonlinearity
LMC662	(D01)	1.4 ppm
LMC6482	(D03)	1.1 ppm
LMC6492	(D02)	1.1 ppm
LMC6022	(D07B)	0.3 ppm
LMC6042	(D06A)	0.3 ppm
LMC6062	(D08)	0.2 ppm
LMC6572	(D05A)	0.2 ppm

## Low Voltage Amplifiers with $\sim$ Rail-to-Rail outputs and with $\pm 2$ -Volt output swing (supplies = $\pm 2.5$ volts)

Type	Test	Nonlinearity
LMV358	(F03)	6 ppm
LMV715	(E01)	1 ppm
LMV771	(E04)	0.6 ppm
LMV751	(E02)	0.4 ppm
LMV771	(E03)	0.4 ppm
LMV932	(F02)	0.3 ppm
LMP2012	(F01A)	0.2 ppm

## Very Low Voltage Amplifier with $\sim$ Rail-to-Rail outputs and with $\pm 0.4$ Volt output swing (supplies = $\pm 0.5$ volts)

Type	Test	Nonlinearity
LMV751	(X06)	5 ppm

## Footnotes

1. Ideal amplifiers are characterized in T. Frederiksen's book, "Intuitive IC Opamps", NSC 1984, p. 23.

2. Some wise engineers have pointed out that even a "rail-to-rail" output stage can not literally swing all the way to the rail, even driving as light a load as a megohm, or even 10 megohms. There are practical reasons why an amplifier can not drive a 1 or 10  $\mu$ A load much closer than 10 or 20 mV to either power supply rail: if they tried to run with such a starved bias, the output loops would go out of control. For loads as heavy as 100  $\mu$ A, 20 to 50 mV is a practical overhead or "drop-out" limitation. For 1 or 2 mA, the drop-out is in the vicinity of 100 to 200 mV. For typical real data, refer to the specific amplifier's data sheet. The typical curves of "Output Characteristics, Current Sourcing" and "Output Characteristics, Current Sinking" will show what you can expect to get, for this dropout. It may not be terribly small, but at moderate loads, it is a lot better than the 600 or 700 mv of the best amplifiers with emitter followers.

3. "What's All This Common-Centroid Stuff, Anyhow?" <http://www.elecdesign.com/Articles/Index.cfm?ArticleID=6121>  
R. A. Pease, Electronic Design, October 1, 1996.

4. "What's All This Output Impedance Stuff, Anyhow?" R. A. Pease, Electronic Design.

5. Appendix A., List of Operational amplifiers with low distortion at dc and low frequencies

## Notes

For more National Semiconductor product information and proven design tools, visit the following Web sites at:

Products		Design Support	
Amplifiers	<a href="http://www.national.com/amplifiers">www.national.com/amplifiers</a>	WEBENCH	<a href="http://www.national.com/webench">www.national.com/webench</a>
Audio	<a href="http://www.national.com/audio">www.national.com/audio</a>	Analog University	<a href="http://www.national.com/AU">www.national.com/AU</a>
Clock Conditioners	<a href="http://www.national.com/timing">www.national.com/timing</a>	App Notes	<a href="http://www.national.com/appnotes">www.national.com/appnotes</a>
Data Converters	<a href="http://www.national.com/adc">www.national.com/adc</a>	Distributors	<a href="http://www.national.com/contacts">www.national.com/contacts</a>
Displays	<a href="http://www.national.com/displays">www.national.com/displays</a>	Green Compliance	<a href="http://www.national.com/quality/green">www.national.com/quality/green</a>
Ethernet	<a href="http://www.national.com/ethernet">www.national.com/ethernet</a>	Packaging	<a href="http://www.national.com/packaging">www.national.com/packaging</a>
Interface	<a href="http://www.national.com/interface">www.national.com/interface</a>	Quality and Reliability	<a href="http://www.national.com/quality">www.national.com/quality</a>
LVDS	<a href="http://www.national.com/lvds">www.national.com/lvds</a>	Reference Designs	<a href="http://www.national.com/refdesigns">www.national.com/refdesigns</a>
Power Management	<a href="http://www.national.com/power">www.national.com/power</a>	Feedback	<a href="http://www.national.com/feedback">www.national.com/feedback</a>
Switching Regulators	<a href="http://www.national.com/switchers">www.national.com/switchers</a>		
LDOs	<a href="http://www.national.com/ldo">www.national.com/ldo</a>		
LED Lighting	<a href="http://www.national.com/led">www.national.com/led</a>		
PowerWise	<a href="http://www.national.com/powerwise">www.national.com/powerwise</a>		
Serial Digital Interface (SDI)	<a href="http://www.national.com/sdi">www.national.com/sdi</a>		
Temperature Sensors	<a href="http://www.national.com/tempsensors">www.national.com/tempsensors</a>		
Wireless (PLL/VCO)	<a href="http://www.national.com/wireless">www.national.com/wireless</a>		

THE CONTENTS OF THIS DOCUMENT ARE PROVIDED IN CONNECTION WITH NATIONAL SEMICONDUCTOR CORPORATION ("NATIONAL") PRODUCTS. NATIONAL MAKES NO REPRESENTATIONS OR WARRANTIES WITH RESPECT TO THE ACCURACY OR COMPLETENESS OF THE CONTENTS OF THIS PUBLICATION AND RESERVES THE RIGHT TO MAKE CHANGES TO SPECIFICATIONS AND PRODUCT DESCRIPTIONS AT ANY TIME WITHOUT NOTICE. NO LICENSE, WHETHER EXPRESS, IMPLIED, ARISING BY ESTOPPEL OR OTHERWISE, TO ANY INTELLECTUAL PROPERTY RIGHTS IS GRANTED BY THIS DOCUMENT.

TESTING AND OTHER QUALITY CONTROLS ARE USED TO THE EXTENT NATIONAL DEEMS NECESSARY TO SUPPORT NATIONAL'S PRODUCT WARRANTY. EXCEPT WHERE MANDATED BY GOVERNMENT REQUIREMENTS, TESTING OF ALL PARAMETERS OF EACH PRODUCT IS NOT NECESSARILY PERFORMED. NATIONAL ASSUMES NO LIABILITY FOR APPLICATIONS ASSISTANCE OR BUYER PRODUCT DESIGN. BUYERS ARE RESPONSIBLE FOR THEIR PRODUCTS AND APPLICATIONS USING NATIONAL COMPONENTS. PRIOR TO USING OR DISTRIBUTING ANY PRODUCTS THAT INCLUDE NATIONAL COMPONENTS, BUYERS SHOULD PROVIDE ADEQUATE DESIGN, TESTING AND OPERATING SAFEGUARDS.

EXCEPT AS PROVIDED IN NATIONAL'S TERMS AND CONDITIONS OF SALE FOR SUCH PRODUCTS, NATIONAL ASSUMES NO LIABILITY WHATSOEVER, AND NATIONAL DISCLAIMS ANY EXPRESS OR IMPLIED WARRANTY RELATING TO THE SALE AND/OR USE OF NATIONAL PRODUCTS INCLUDING LIABILITY OR WARRANTIES RELATING TO FITNESS FOR A PARTICULAR PURPOSE, MERCHANTABILITY, OR INFRINGEMENT OF ANY PATENT, COPYRIGHT OR OTHER INTELLECTUAL PROPERTY RIGHT.

### LIFE SUPPORT POLICY

**NATIONAL'S PRODUCTS ARE NOT AUTHORIZED FOR USE AS CRITICAL COMPONENTS IN LIFE SUPPORT DEVICES OR SYSTEMS WITHOUT THE EXPRESS PRIOR WRITTEN APPROVAL OF THE CHIEF EXECUTIVE OFFICER AND GENERAL COUNSEL OF NATIONAL SEMICONDUCTOR CORPORATION.** As used herein:

Life support devices or systems are devices which (a) are intended for surgical implant into the body, or (b) support or sustain life and whose failure to perform when properly used in accordance with instructions for use provided in the labeling can be reasonably expected to result in a significant injury to the user. A critical component is any component in a life support device or system whose failure to perform can be reasonably expected to cause the failure of the life support device or system or to affect its safety or effectiveness.

National Semiconductor and the National Semiconductor logo are registered trademarks of National Semiconductor Corporation. All other brand or product names may be trademarks or registered trademarks of their respective holders.

Copyright© 2008 National Semiconductor Corporation

For the most current product information visit us at [www.national.com](http://www.national.com)



**National Semiconductor Americas Technical Support Center**  
 Email: [support@nsc.com](mailto:support@nsc.com)  
 Tel: 1-800-272-9959

**National Semiconductor Europe Technical Support Center**  
 Email: [europe.support@nsc.com](mailto:europe.support@nsc.com)  
 German Tel: +49 (0) 180 5010 771  
 English Tel: +44 (0) 870 850 4288

**National Semiconductor Asia Pacific Technical Support Center**  
 Email: [ap.support@nsc.com](mailto:ap.support@nsc.com)

**National Semiconductor Japan Technical Support Center**  
 Email: [jpn.feedback@nsc.com](mailto:jpn.feedback@nsc.com)